

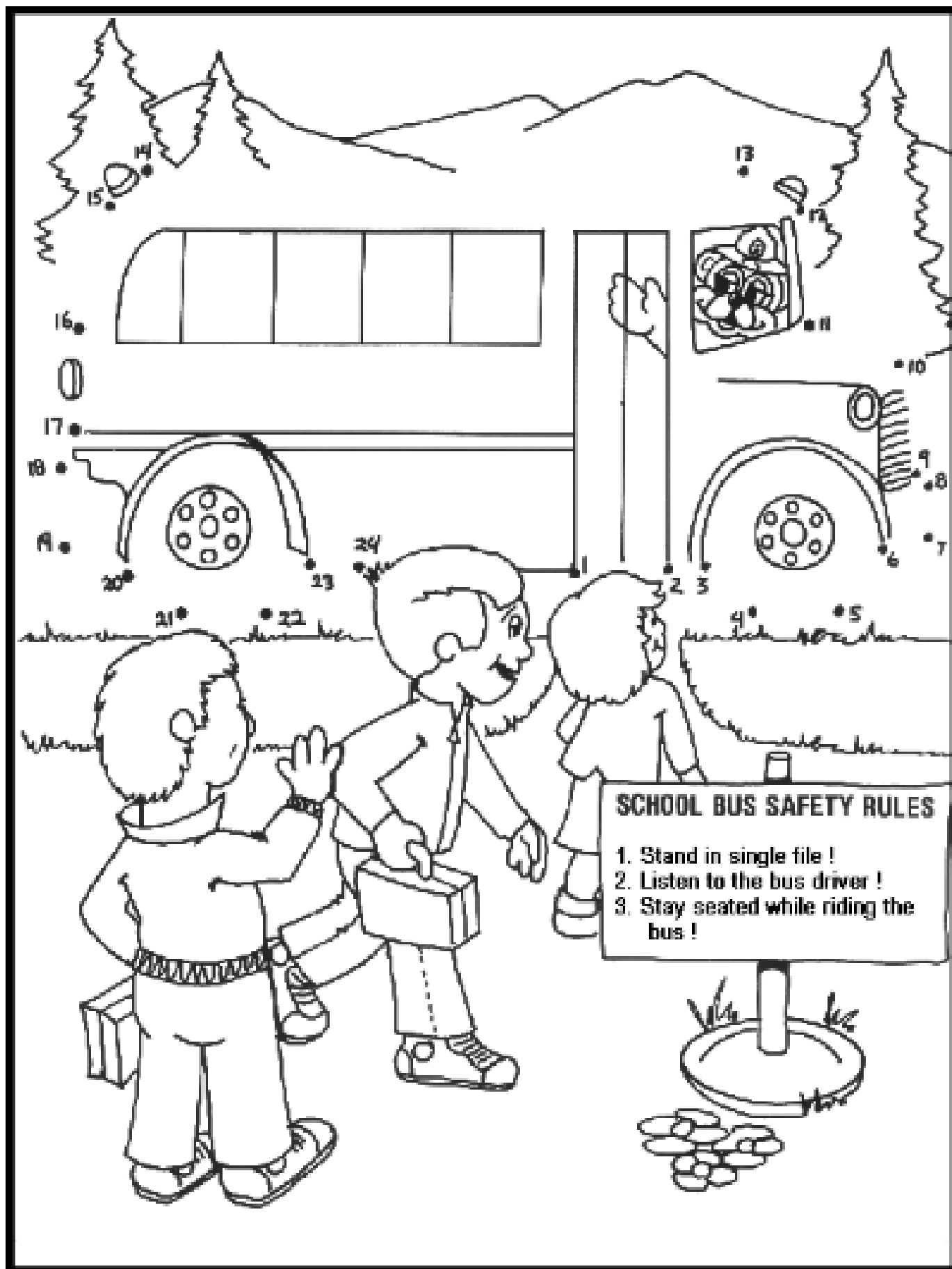

© Yarra Design



© Yoarra Design



### SCHOOL BUS SAFETY RULES

1. Stand in single file !
2. Listen to the bus driver !
3. Stay seated while riding the bus !

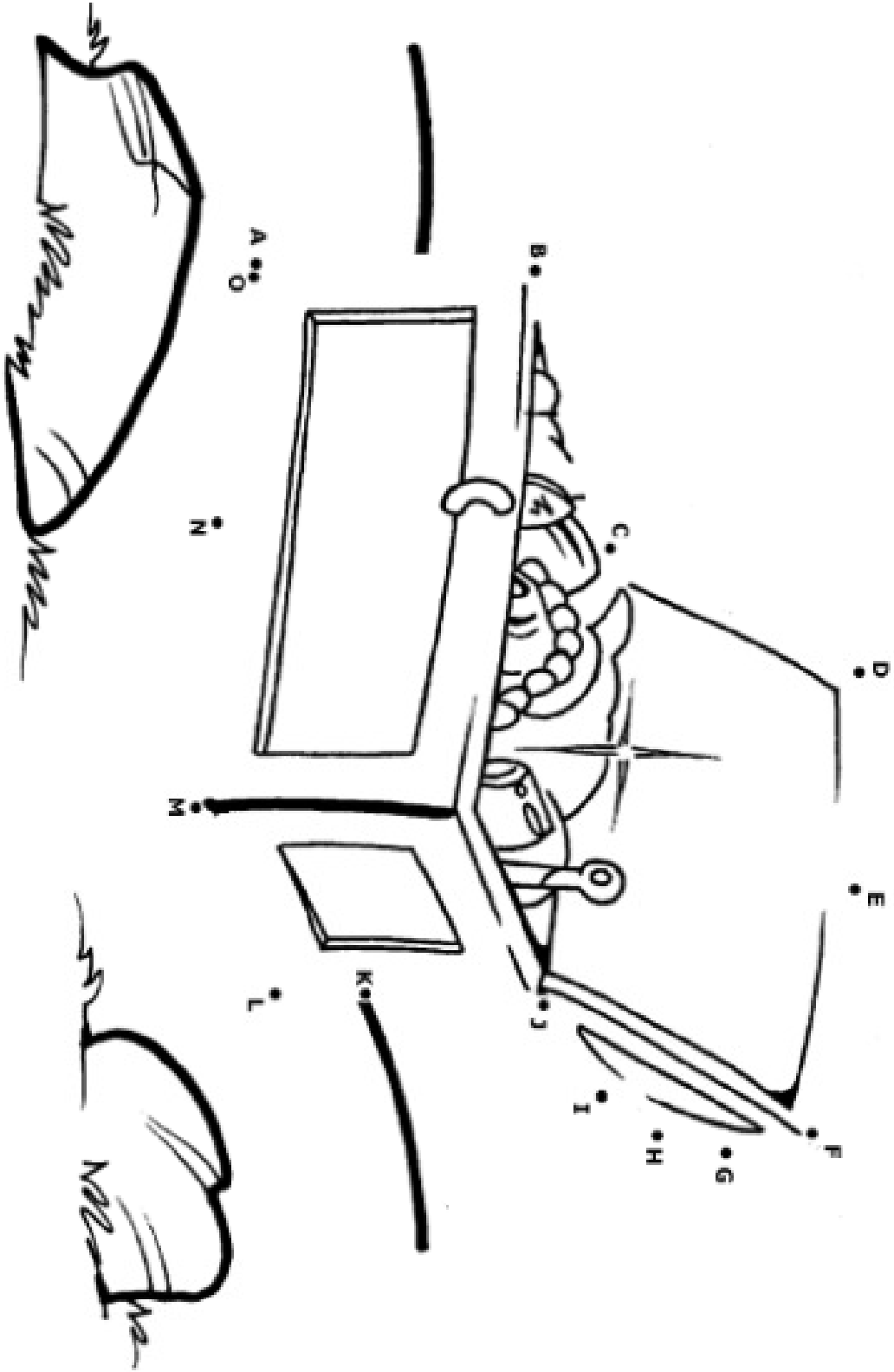

A handwritten signature or scribble, possibly reading "SWZ", located at the bottom left of the page.



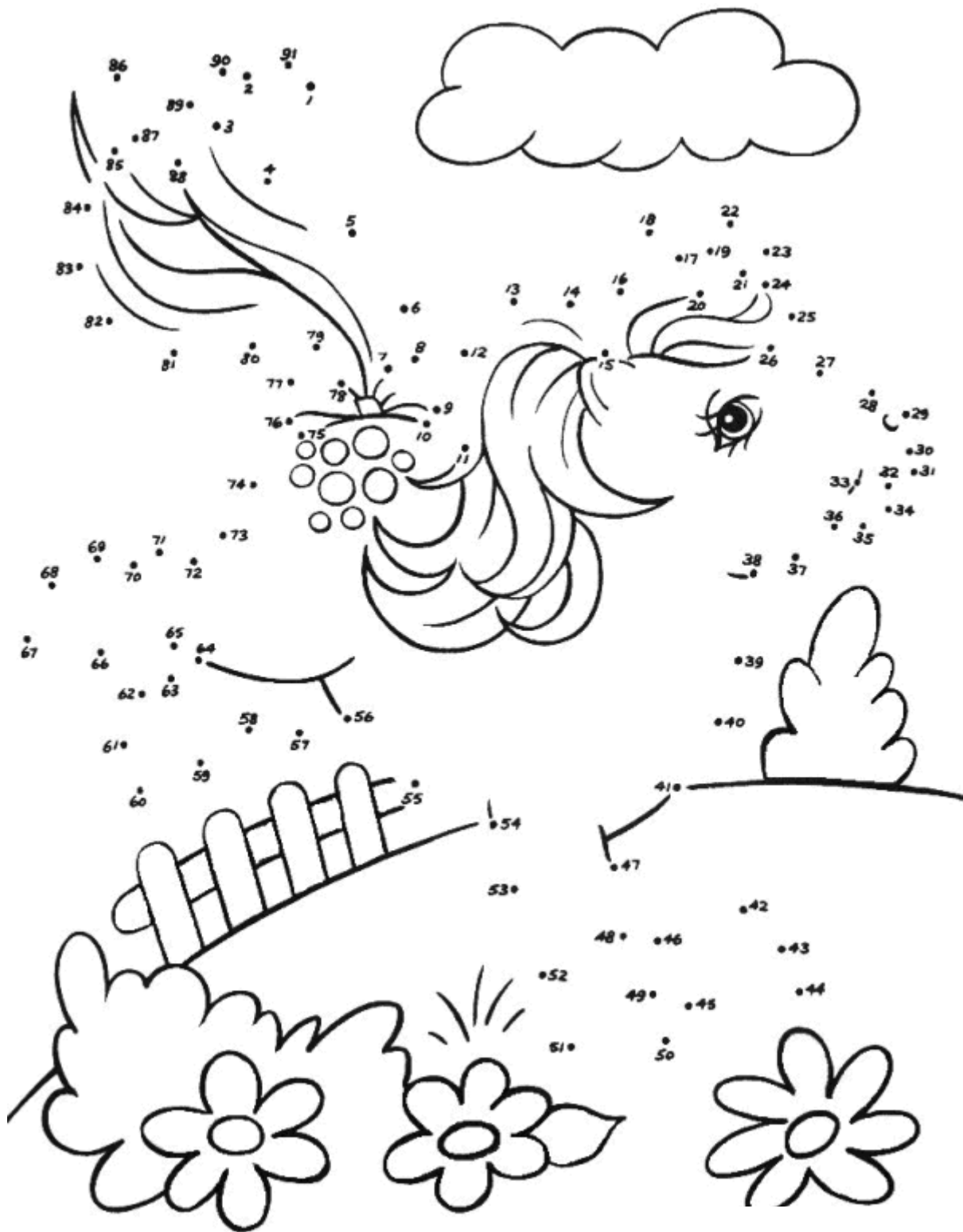

# Green and Golden Bell Frog dot-to-dot

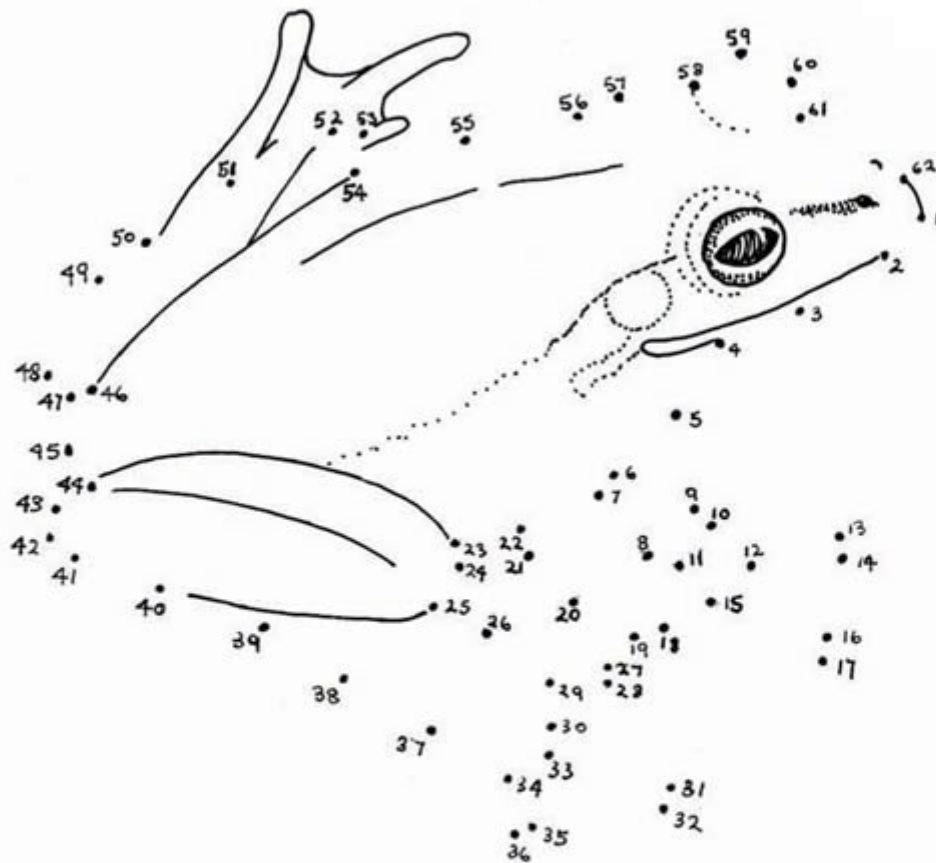

1. Join the dots from 1 to 62
2. Colour in the picture of the Green and Golden Bell Frog
3. Draw and colour in a background that will camouflage your frog



© Yorra Design



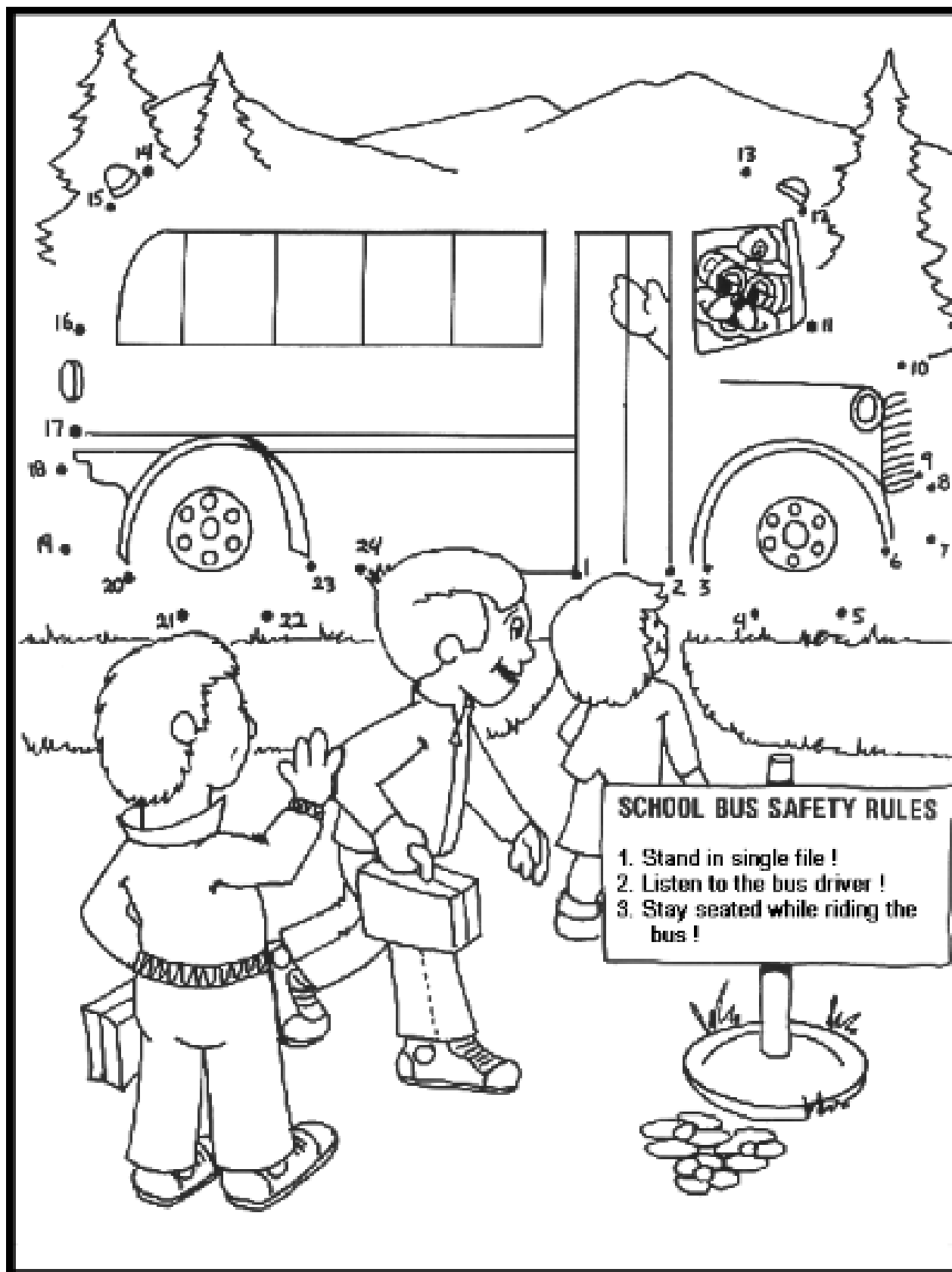

**SCHOOL BUS SAFETY RULES**

1. Stand in single file !
2. Listen to the bus driver !
3. Stay seated while riding the bus !



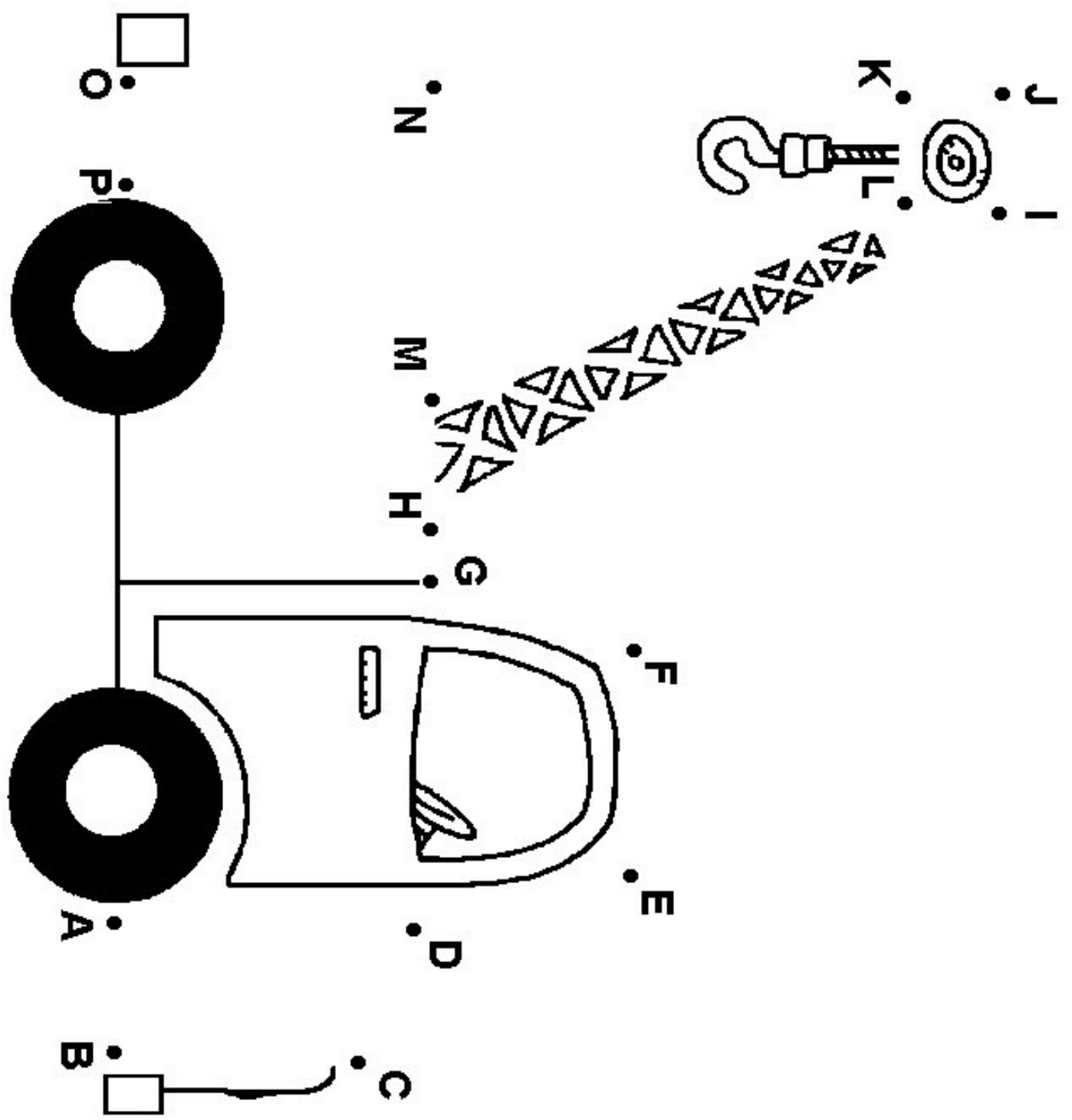



# Connect the dots. Count by 2's

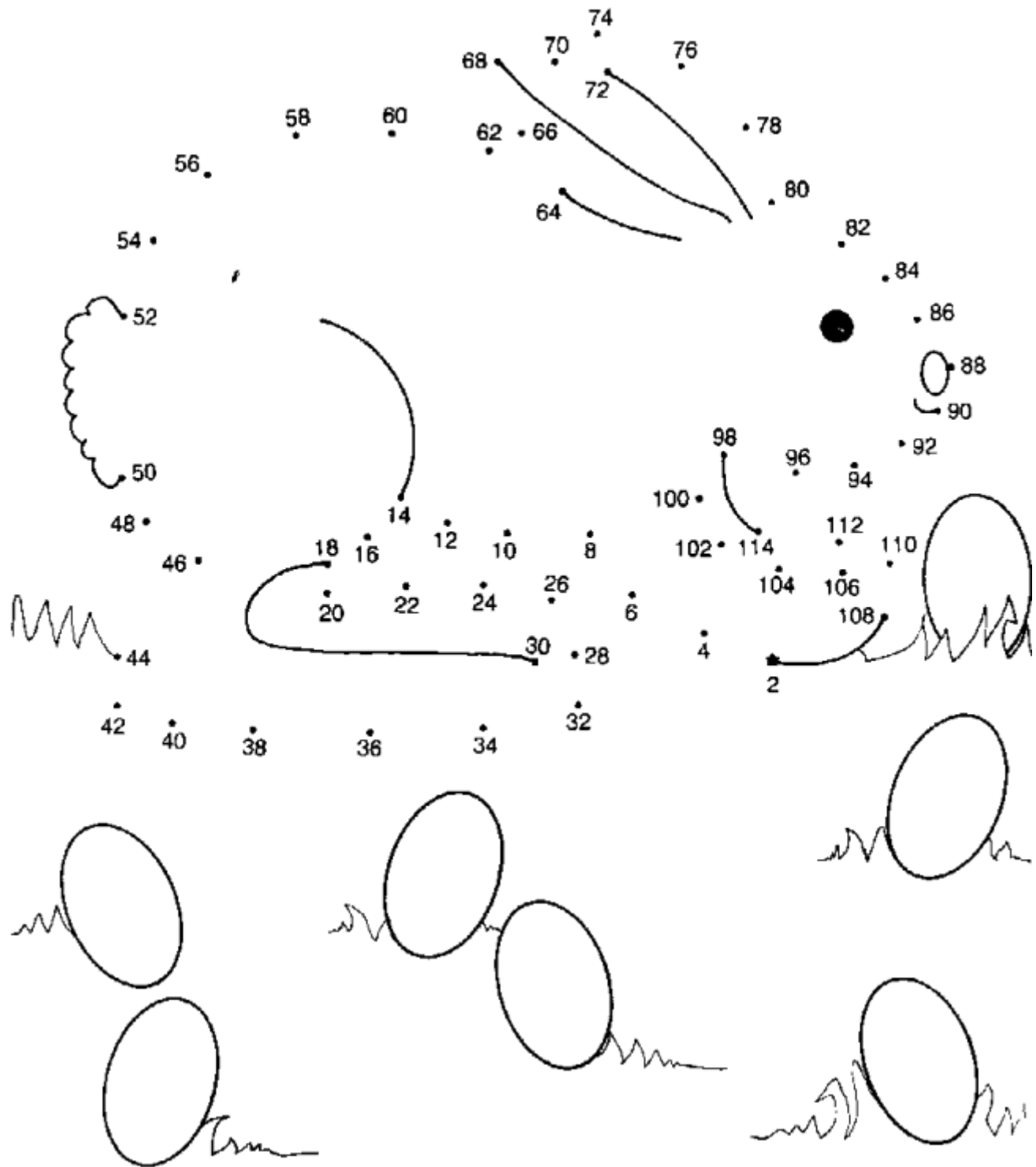

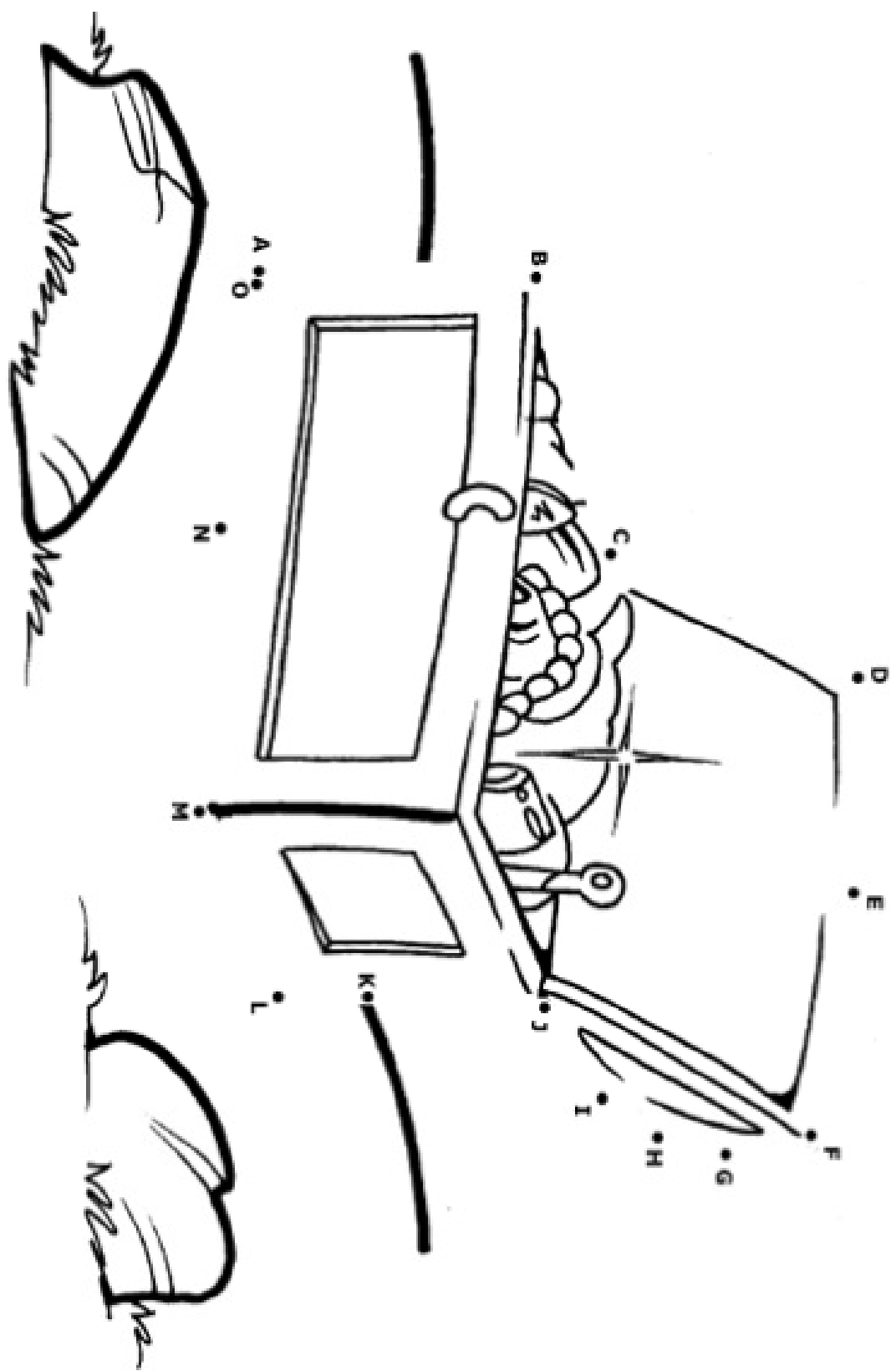

**c o n n e c t**

# the dots

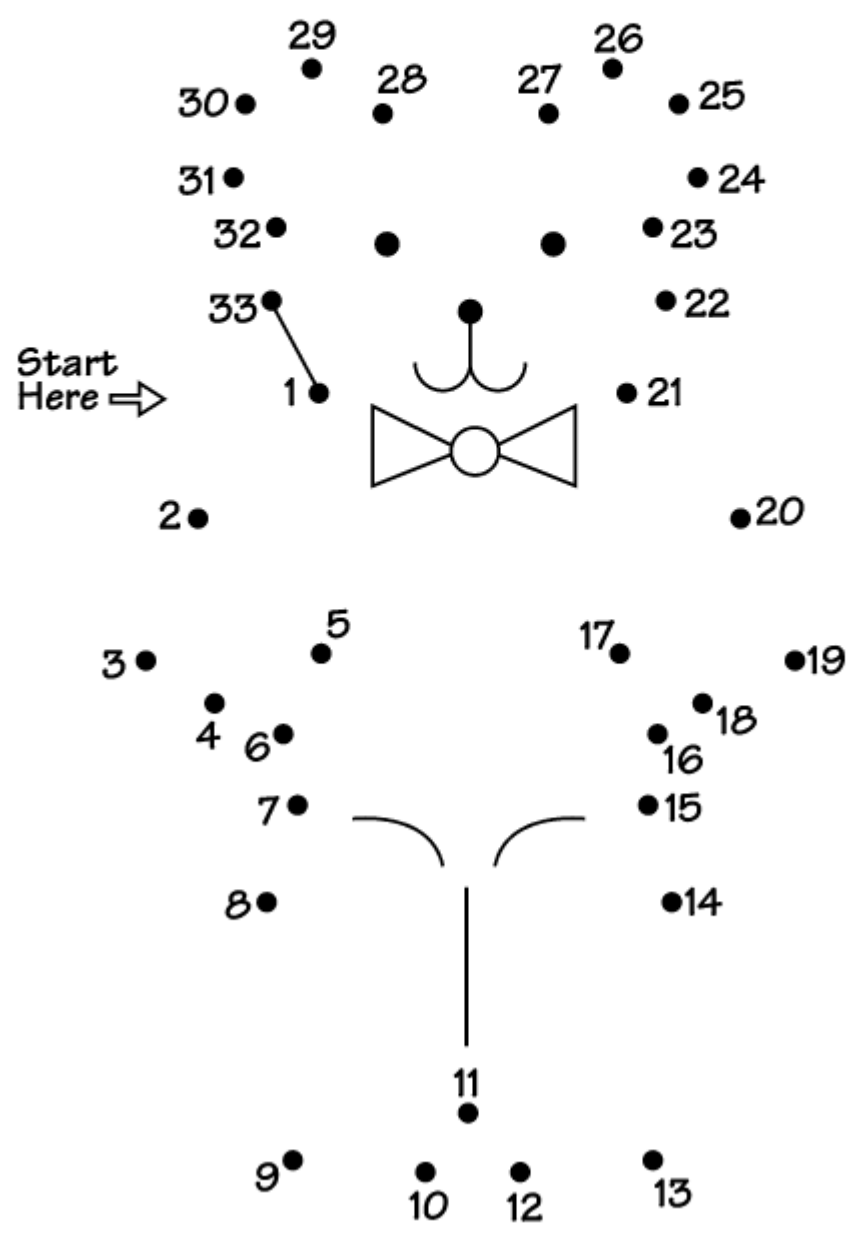





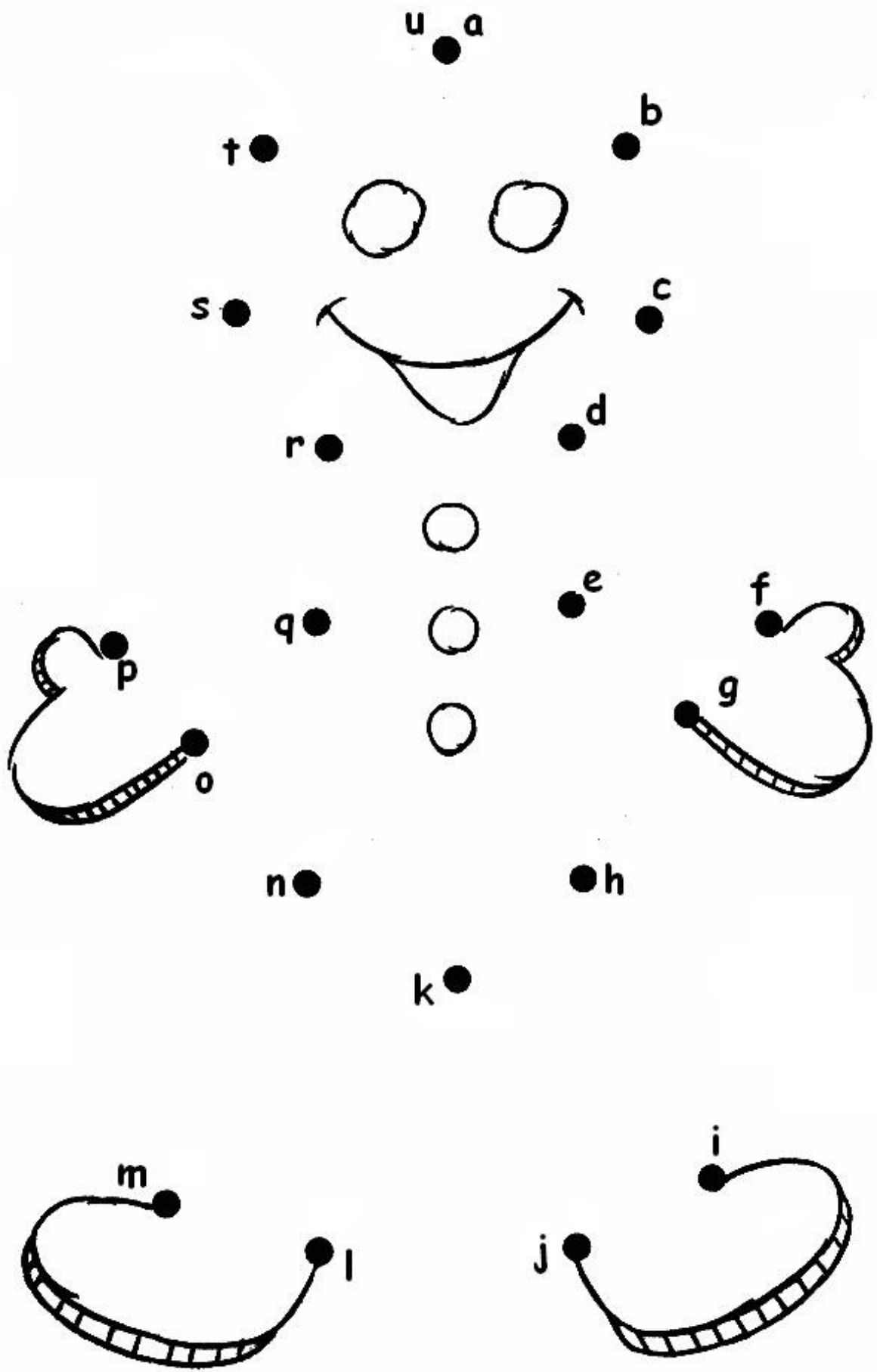



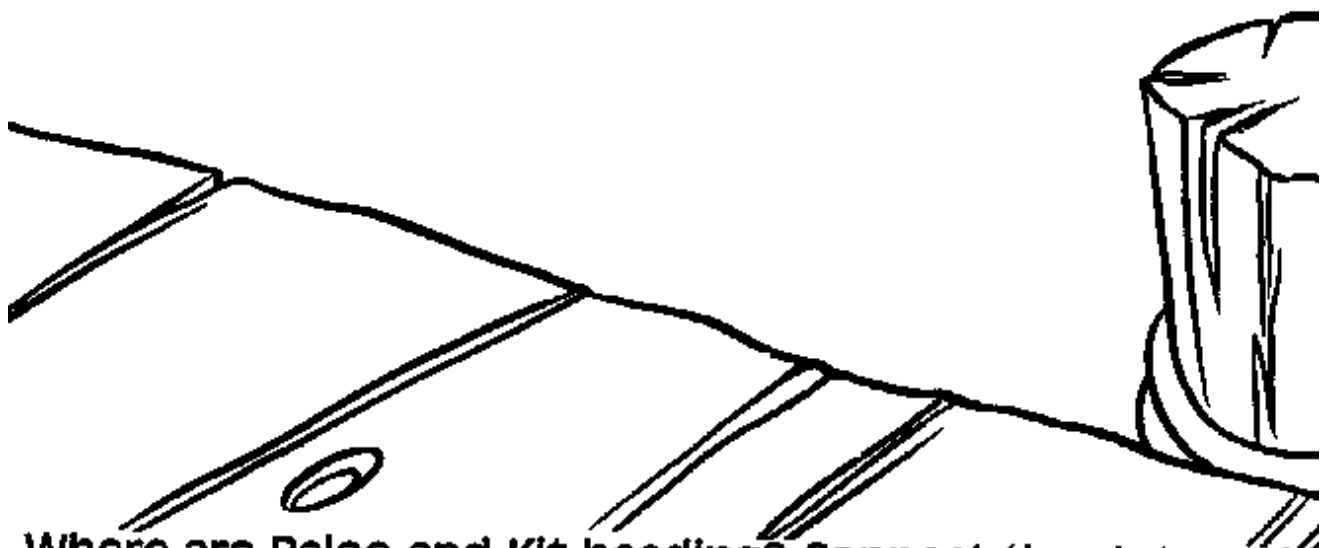
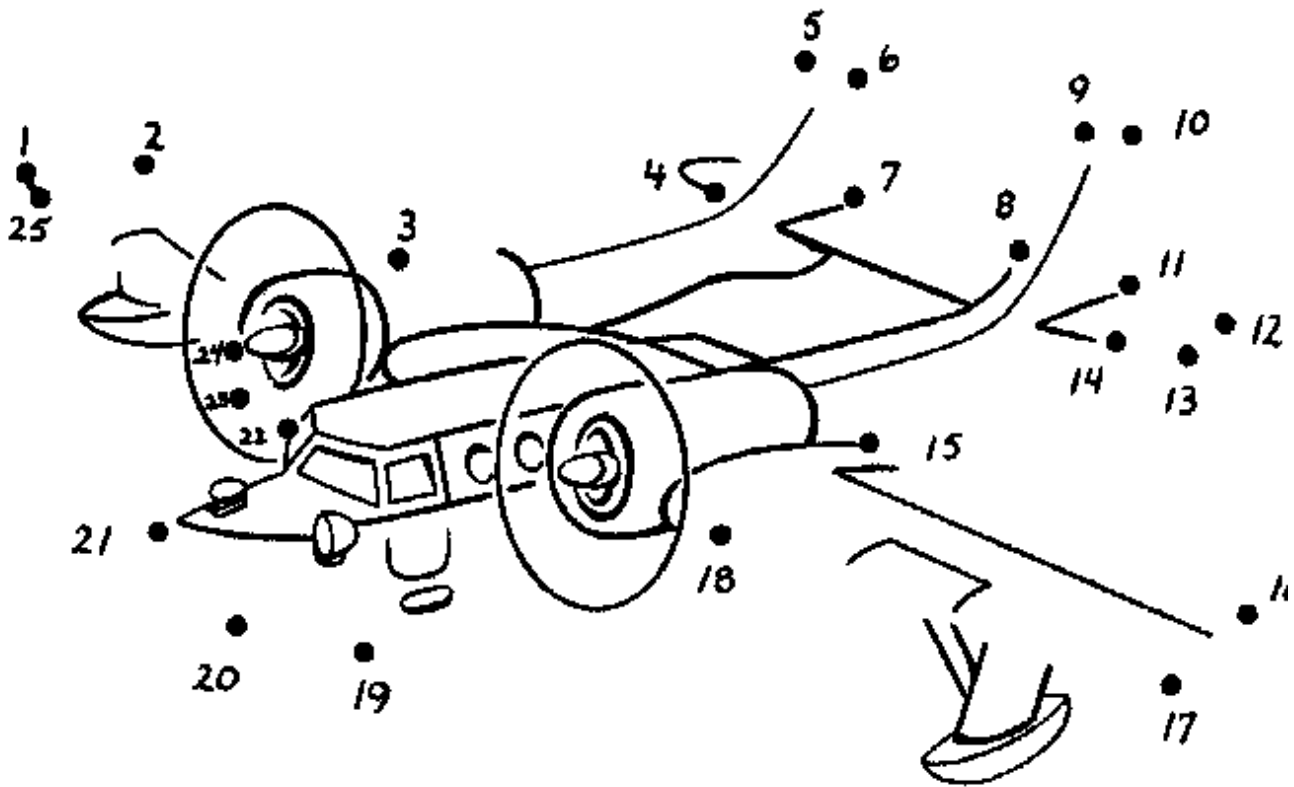

Where are Baloo and Kit heading? Connect the dots and find out.



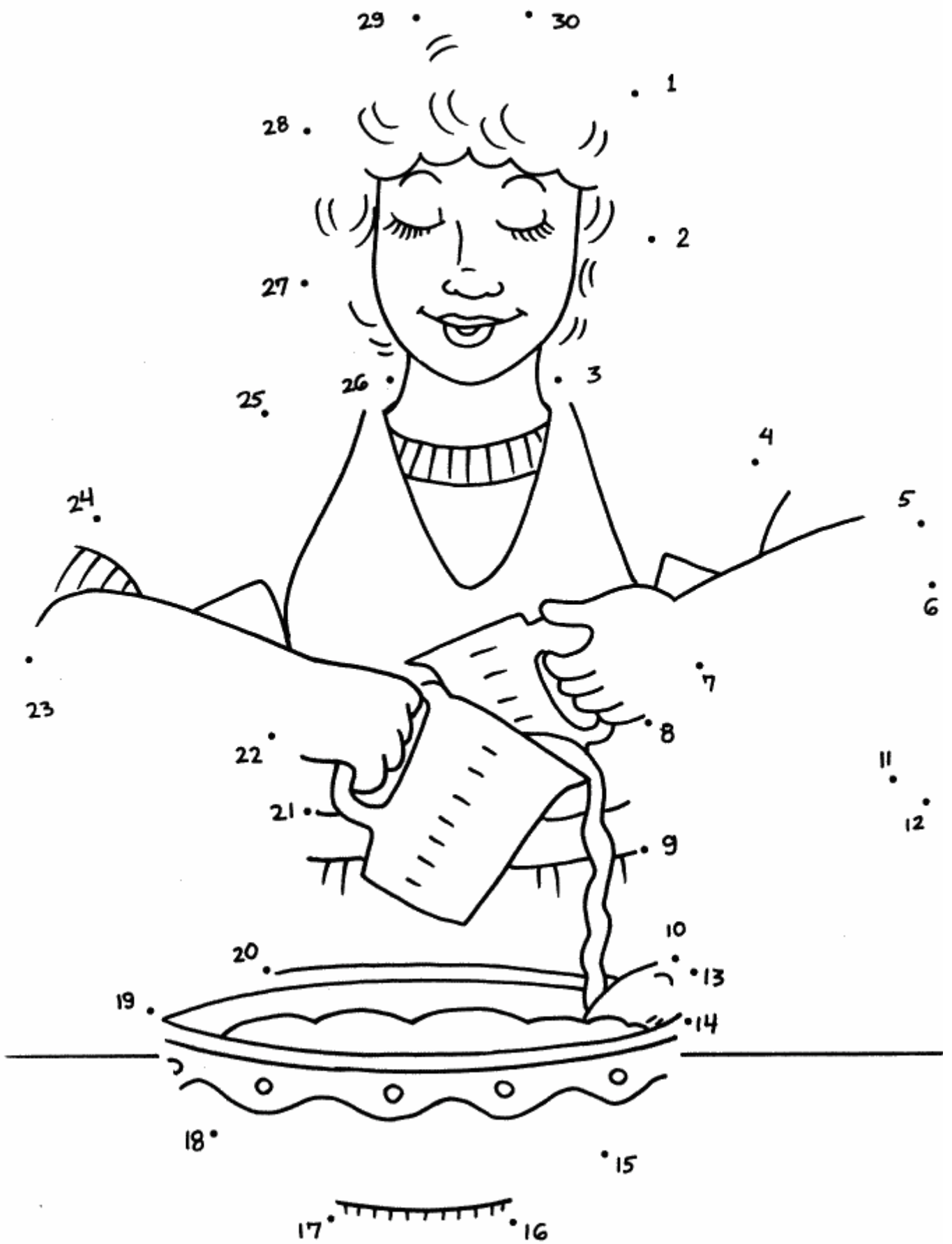



# SCOOBY-DOO™

FIND THE WORDS IN THE PUZZLE.

F R E D N E Y M A H M  
 S Z D I V A N H S A Y  
 L H O U S E E E T U S  
 E Z O I N K S T Y N T  
 U E N M N I L M A T E  
 T E E N A G E R S E R  
 H A O G E R S C L D Y  
 S M A C H I N E Z S O

## WORD SEARCH

FRED  
 ZOINKS  
 HAUNTED

HOUSE  
 MYSTERY  
 MACHINE

VAN  
 SLEUTHS  
 TEENAGERS

# Connect the Dots

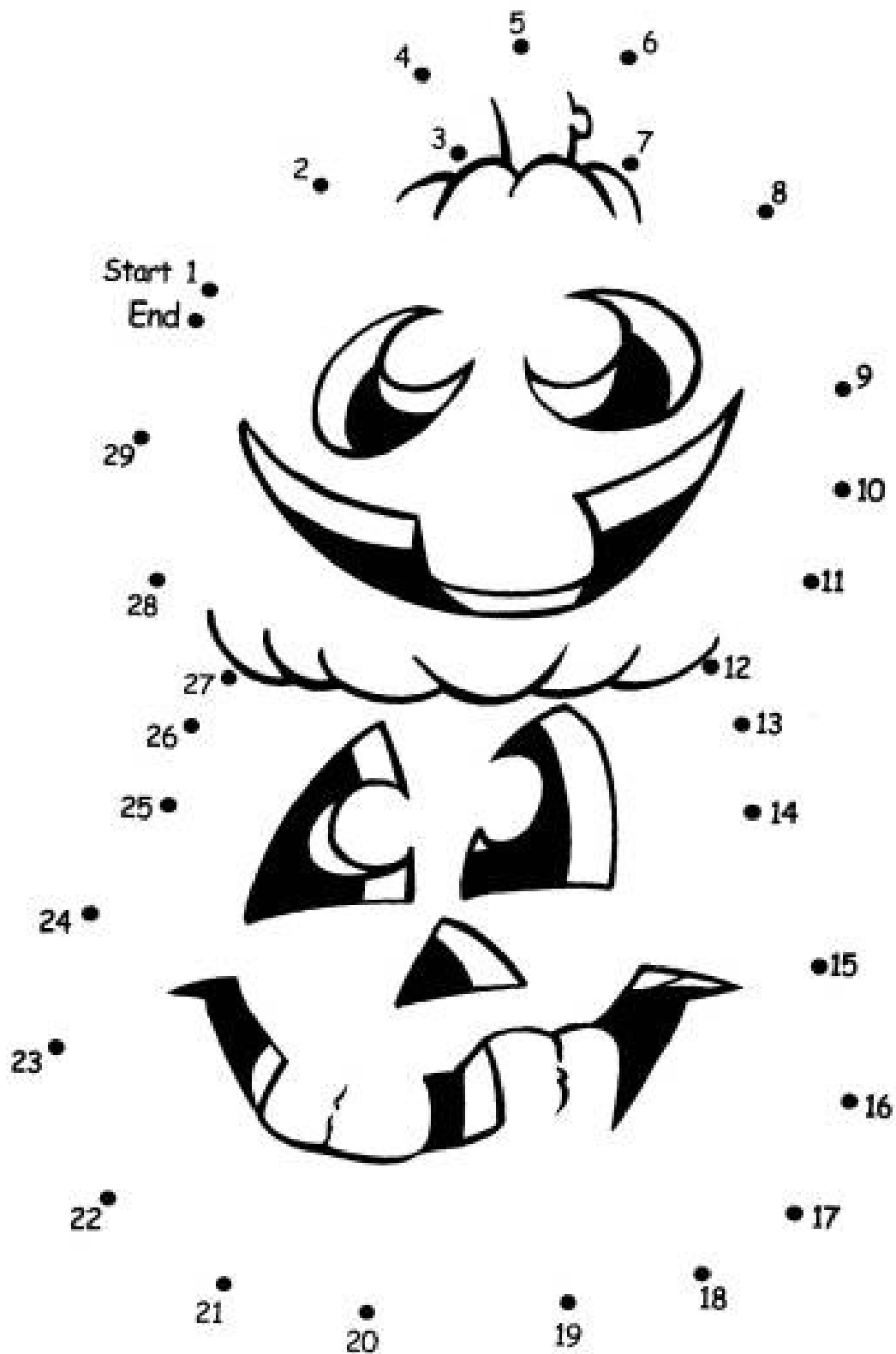

# Dot to Dot - a to z and A to Z

Join the dots to find out what the animal is.



It's a \_\_\_\_\_



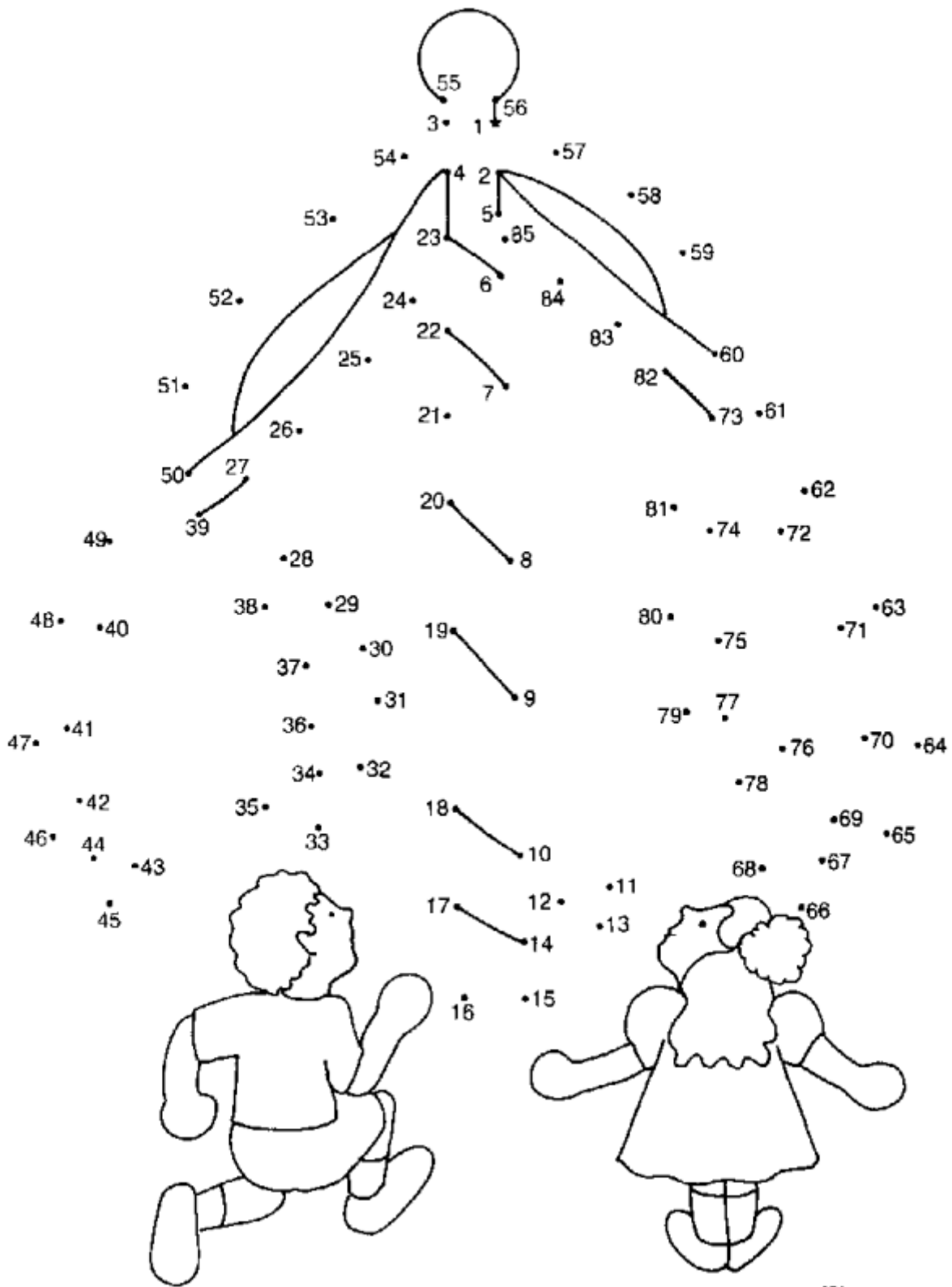

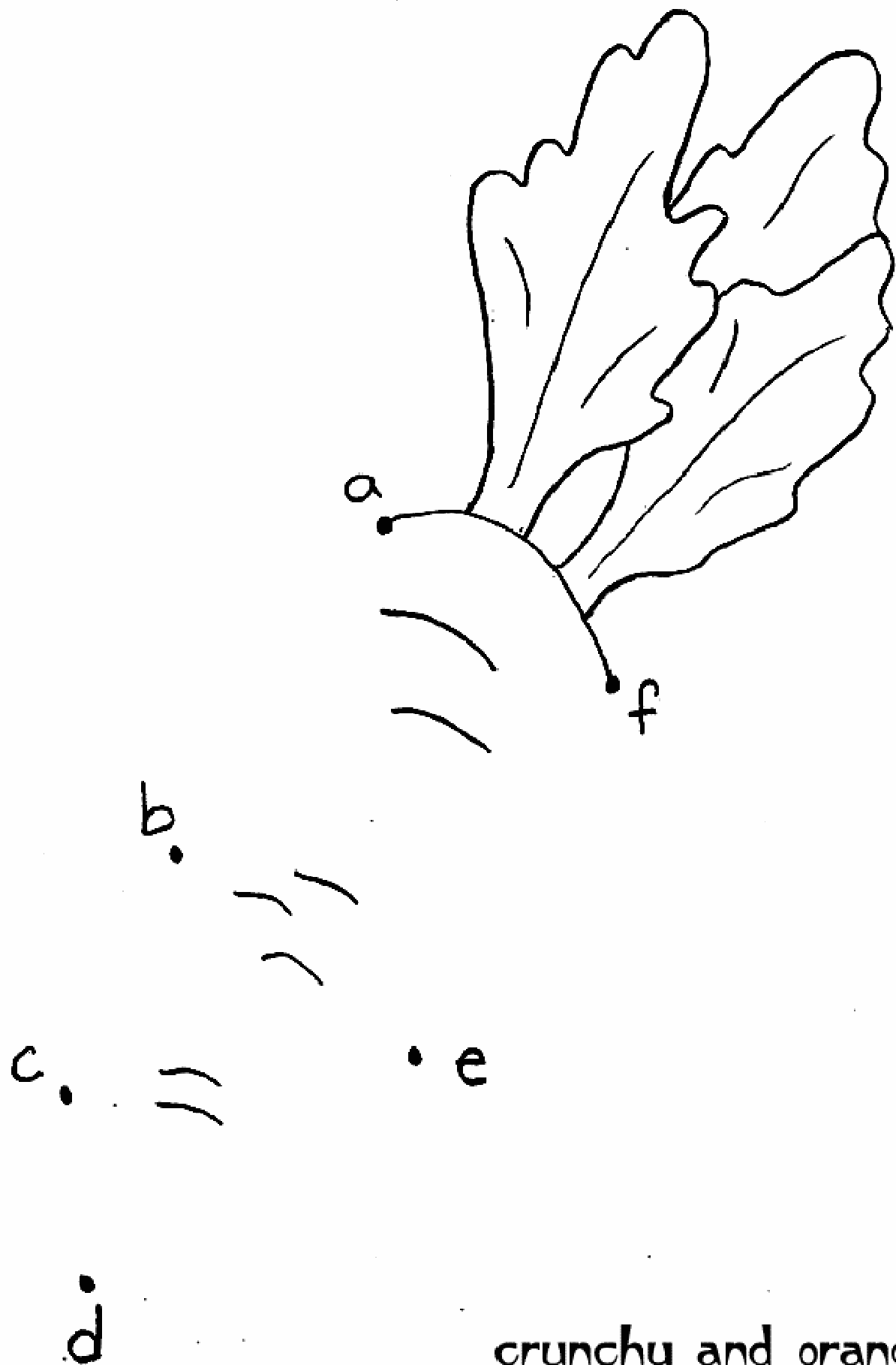

crunchy and orange

Name \_\_\_\_\_

Connect the dots and color. Start with 1.

I love  
Math

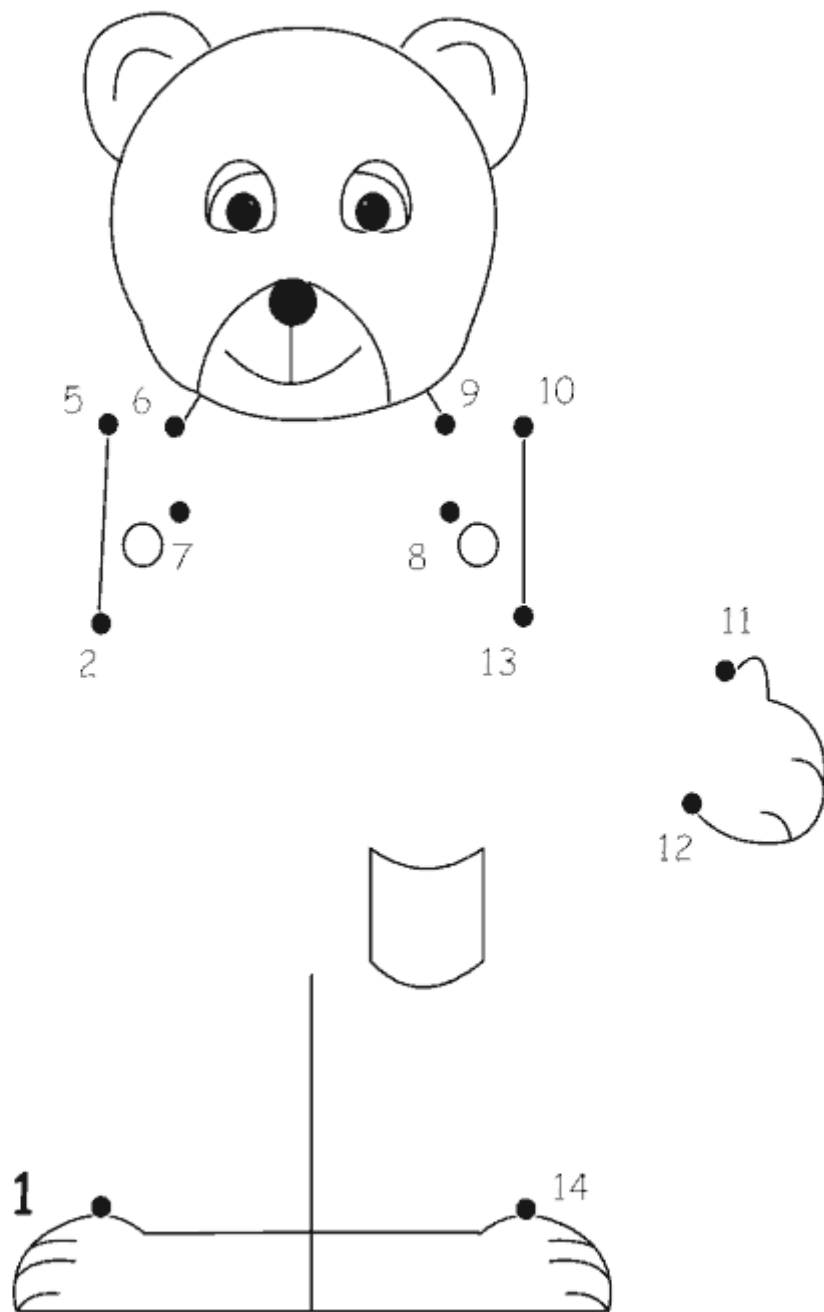

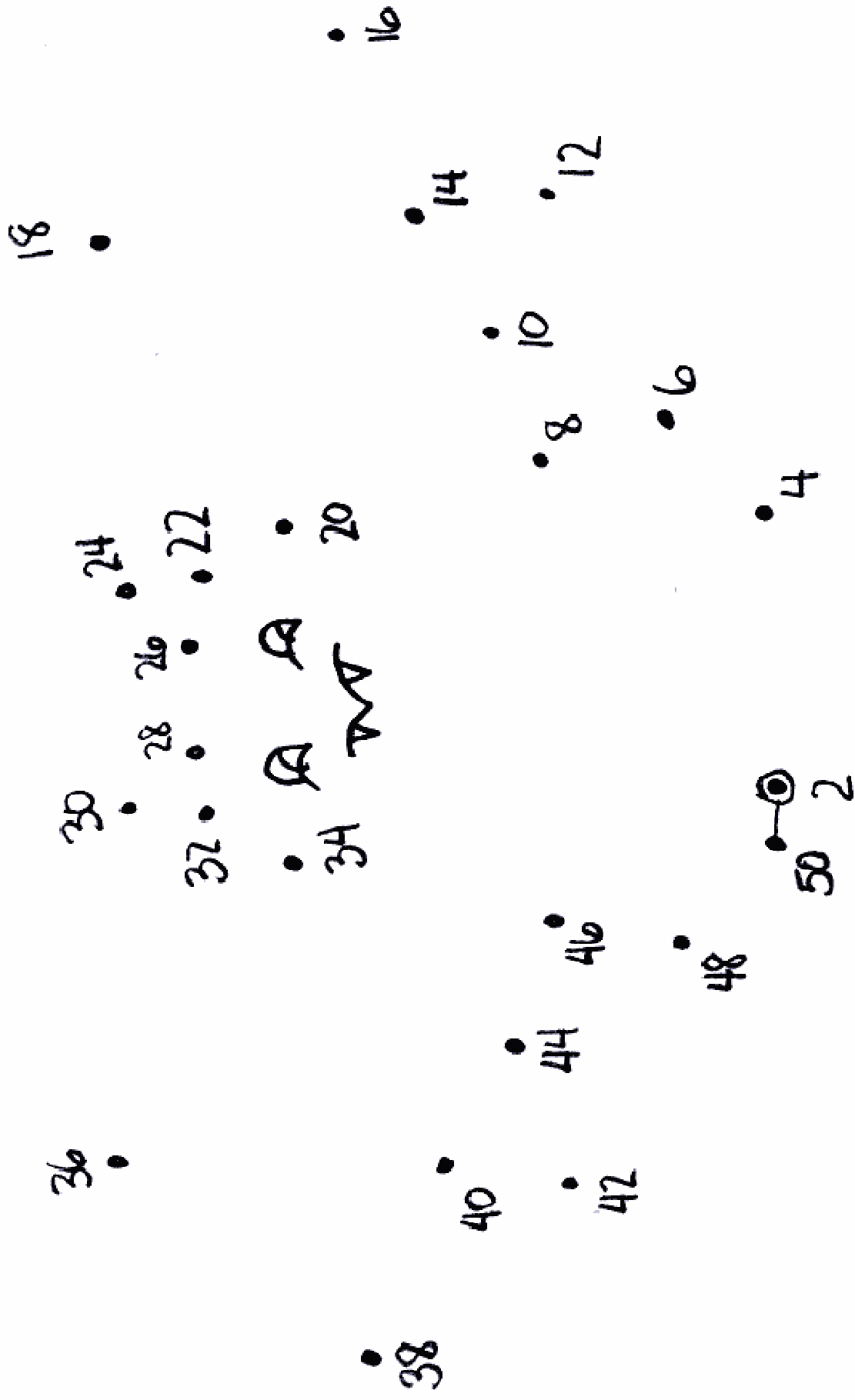

Connect the dots counting by 2's

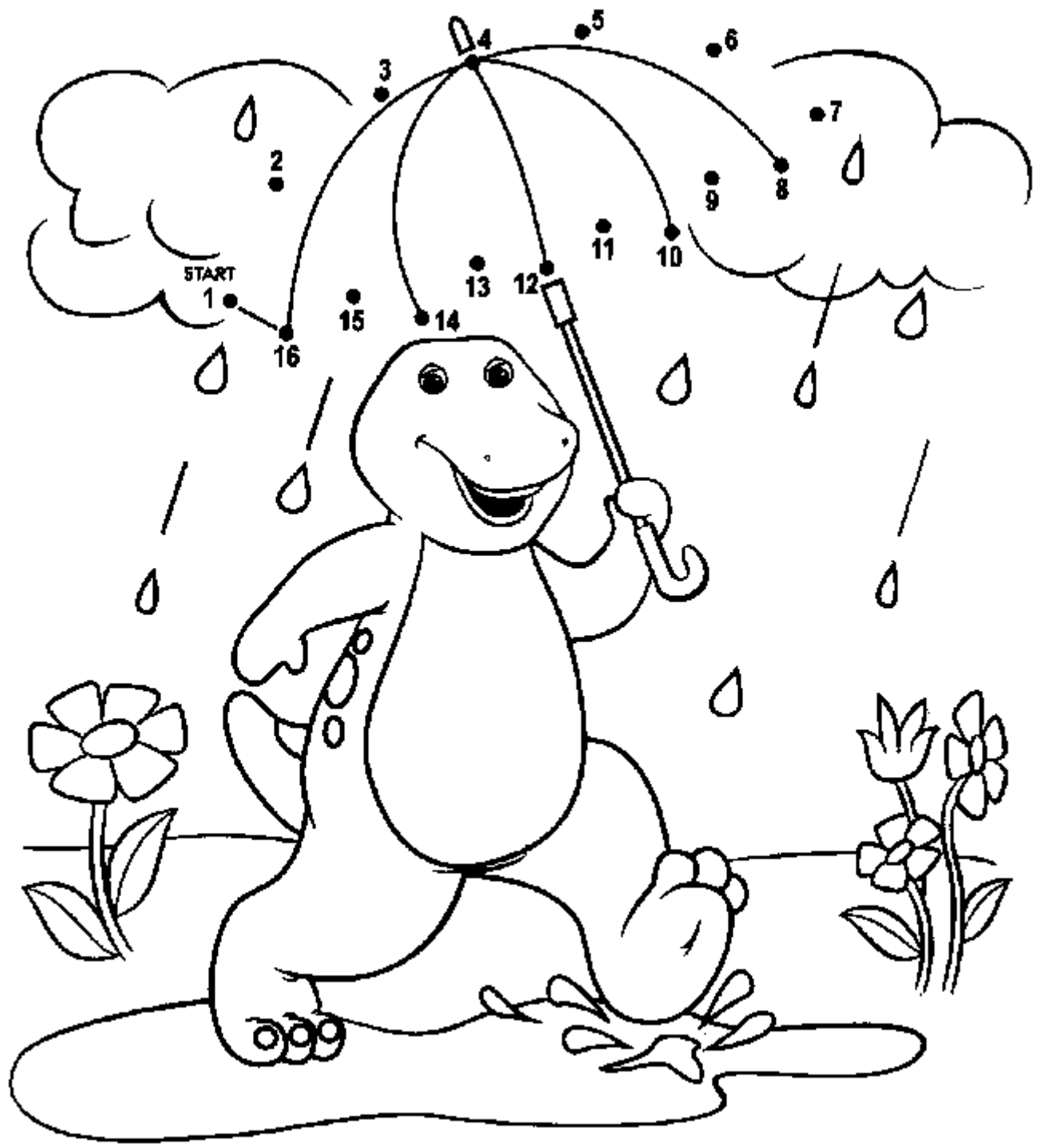









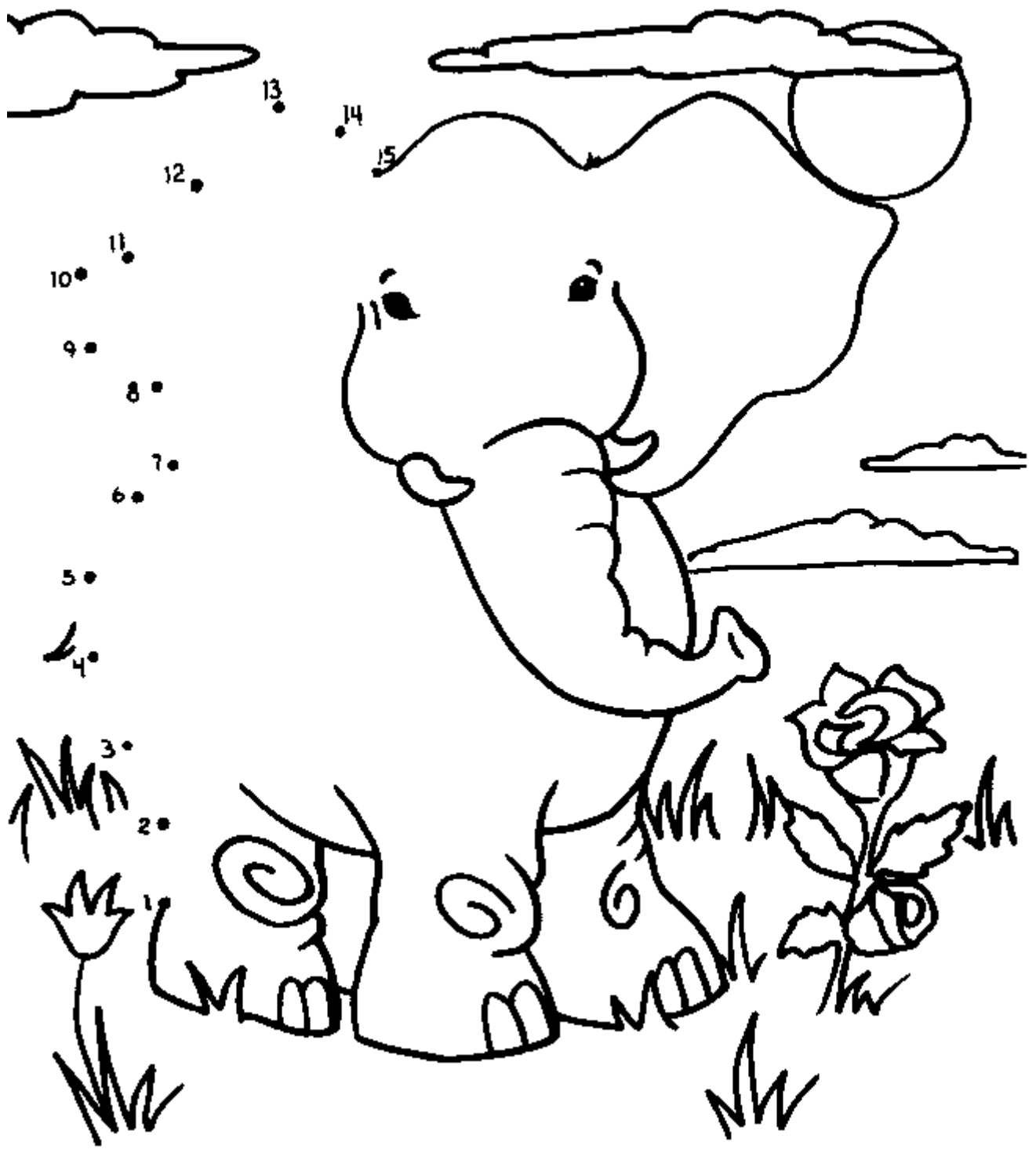

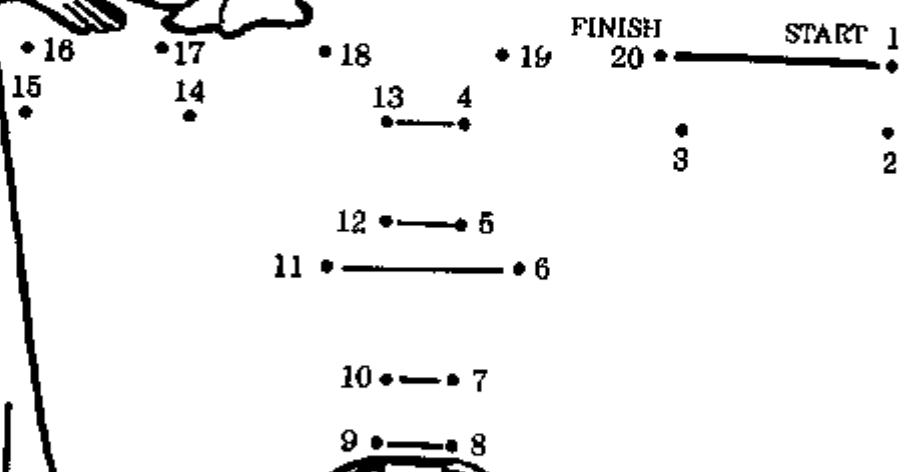
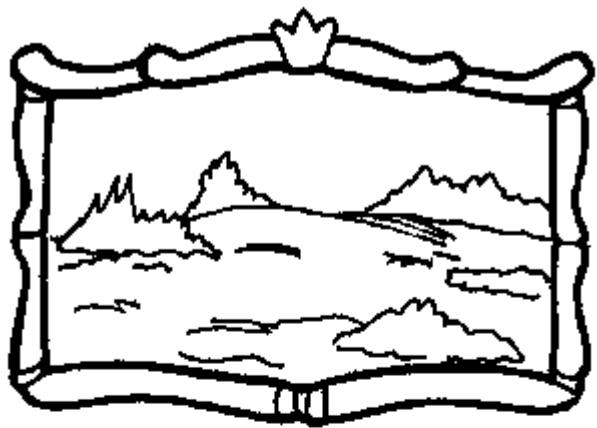
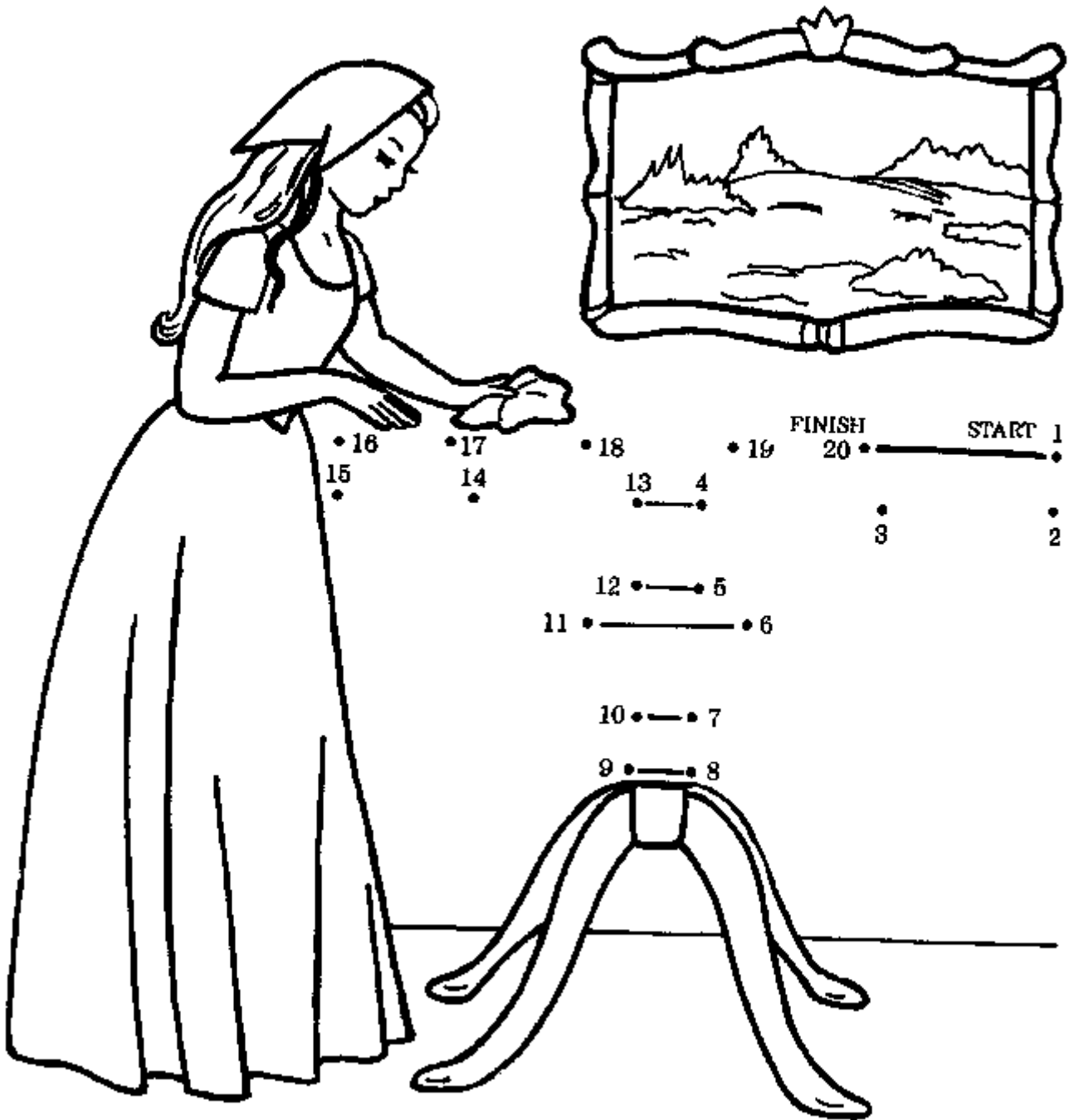

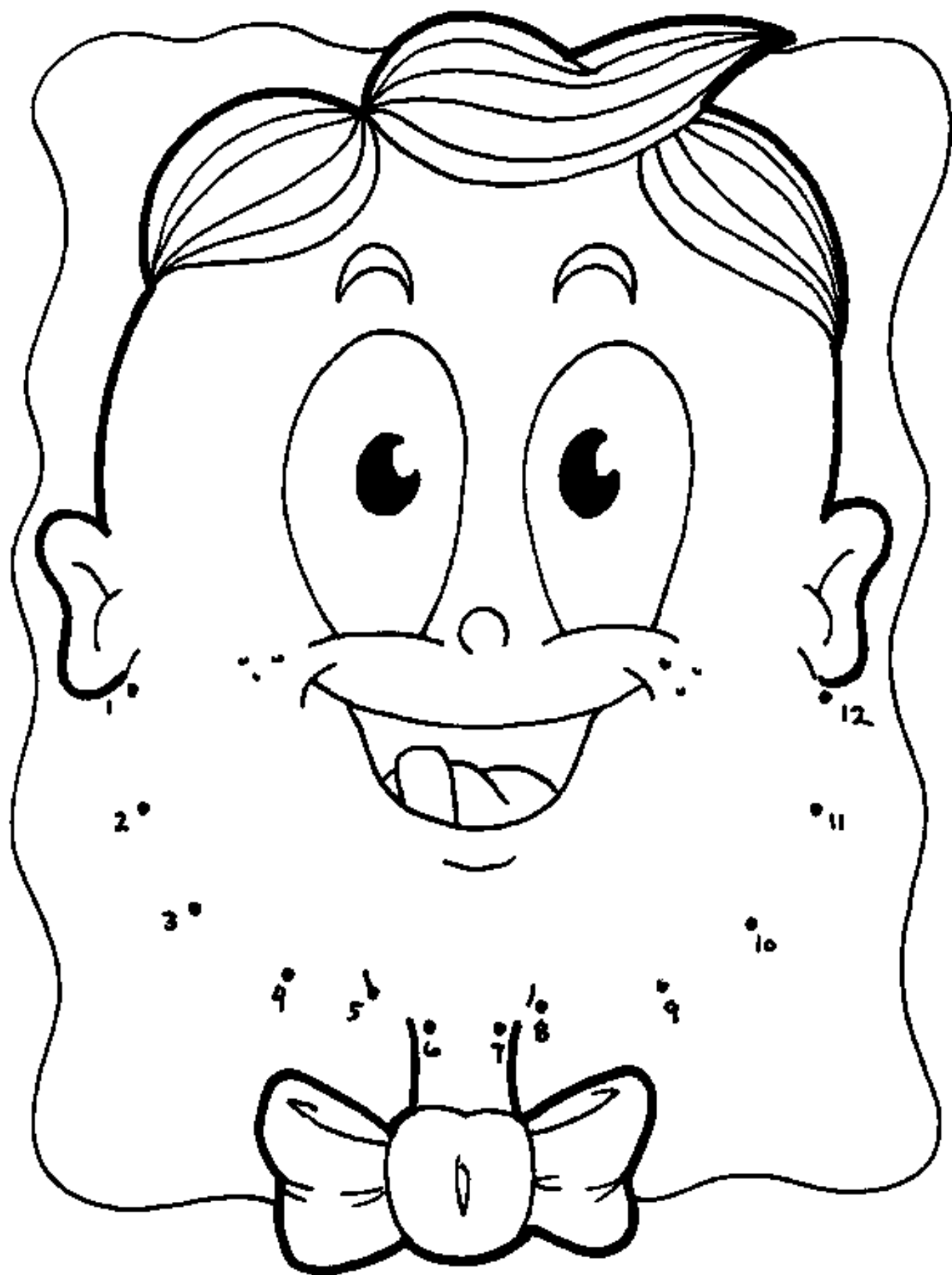

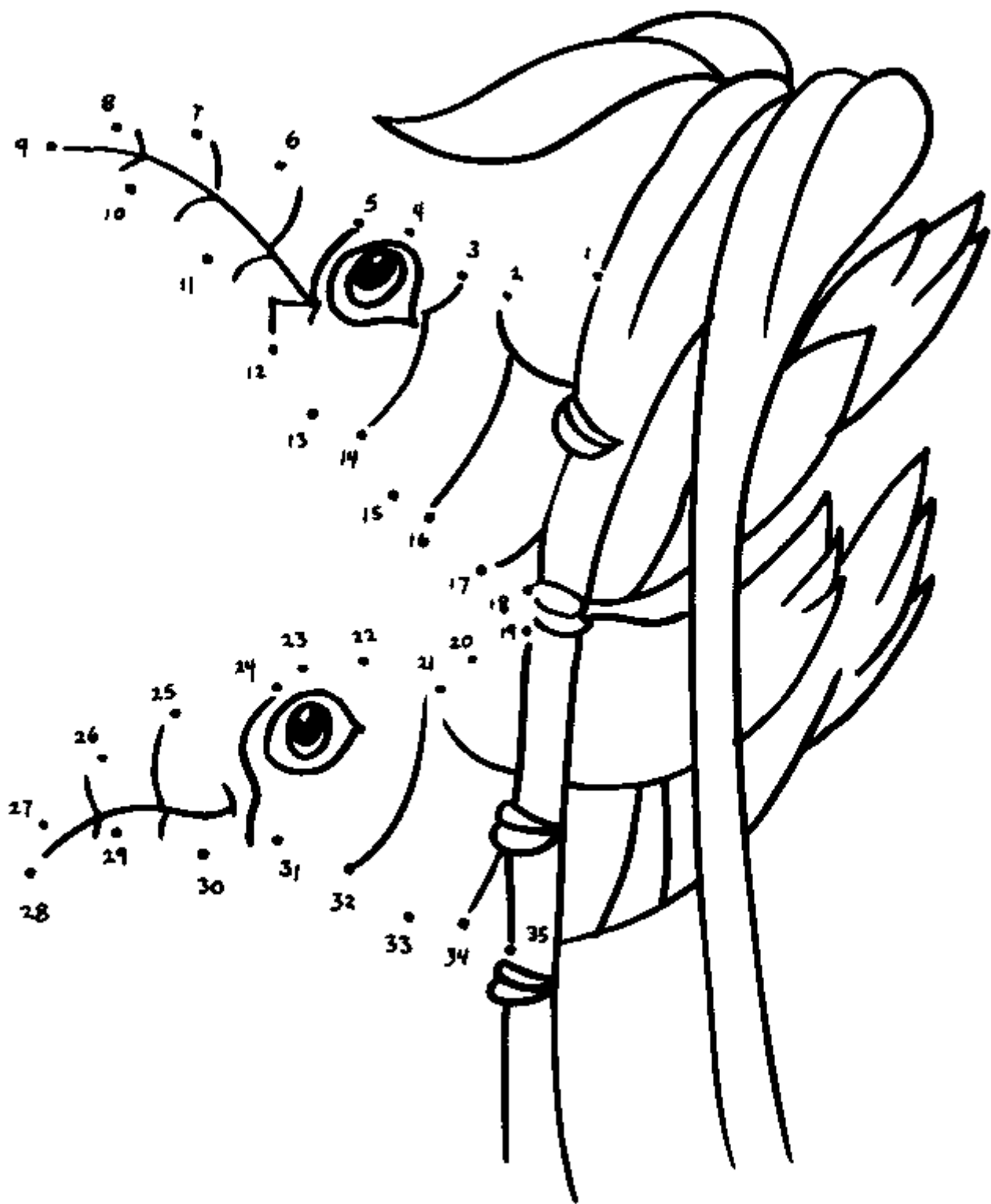

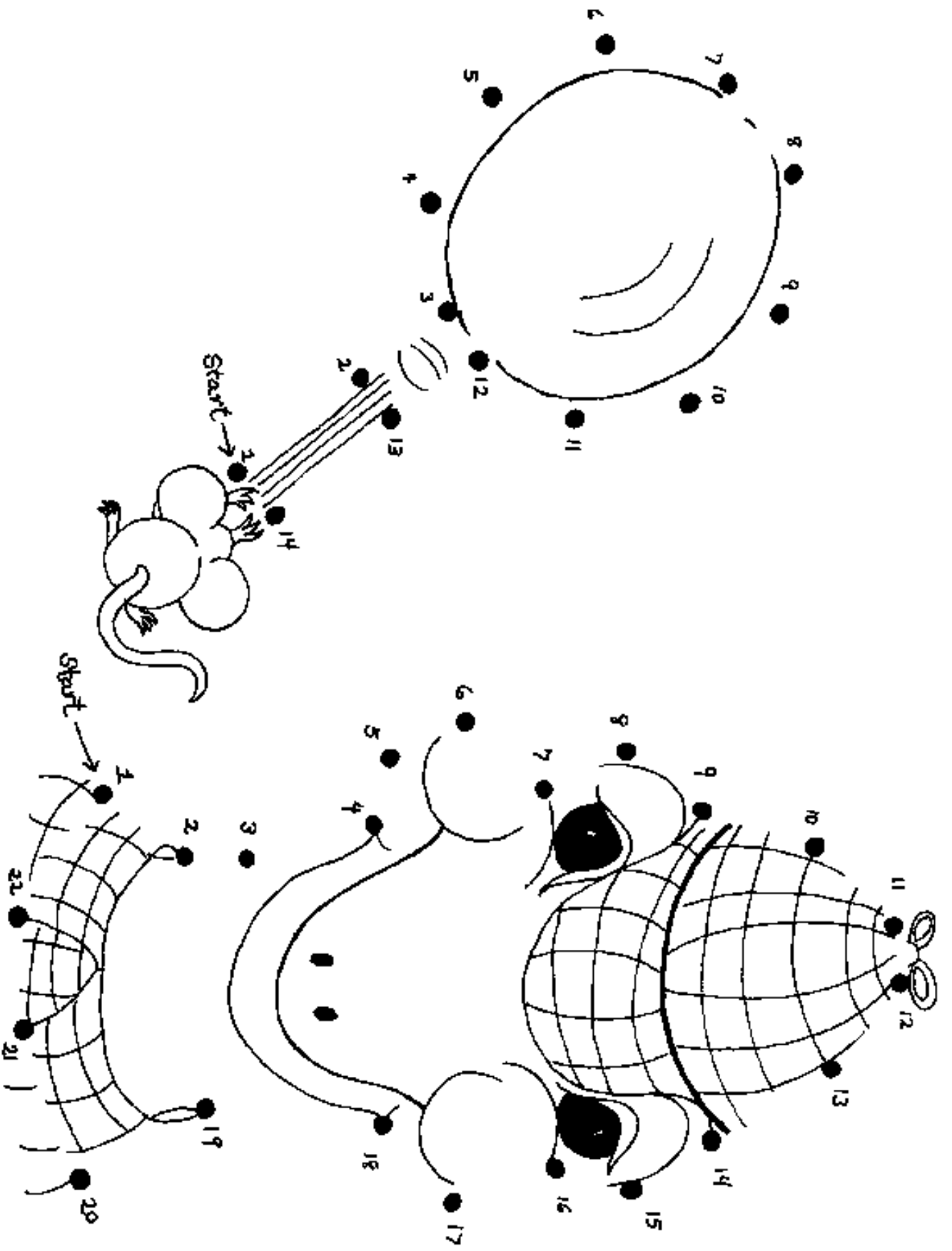

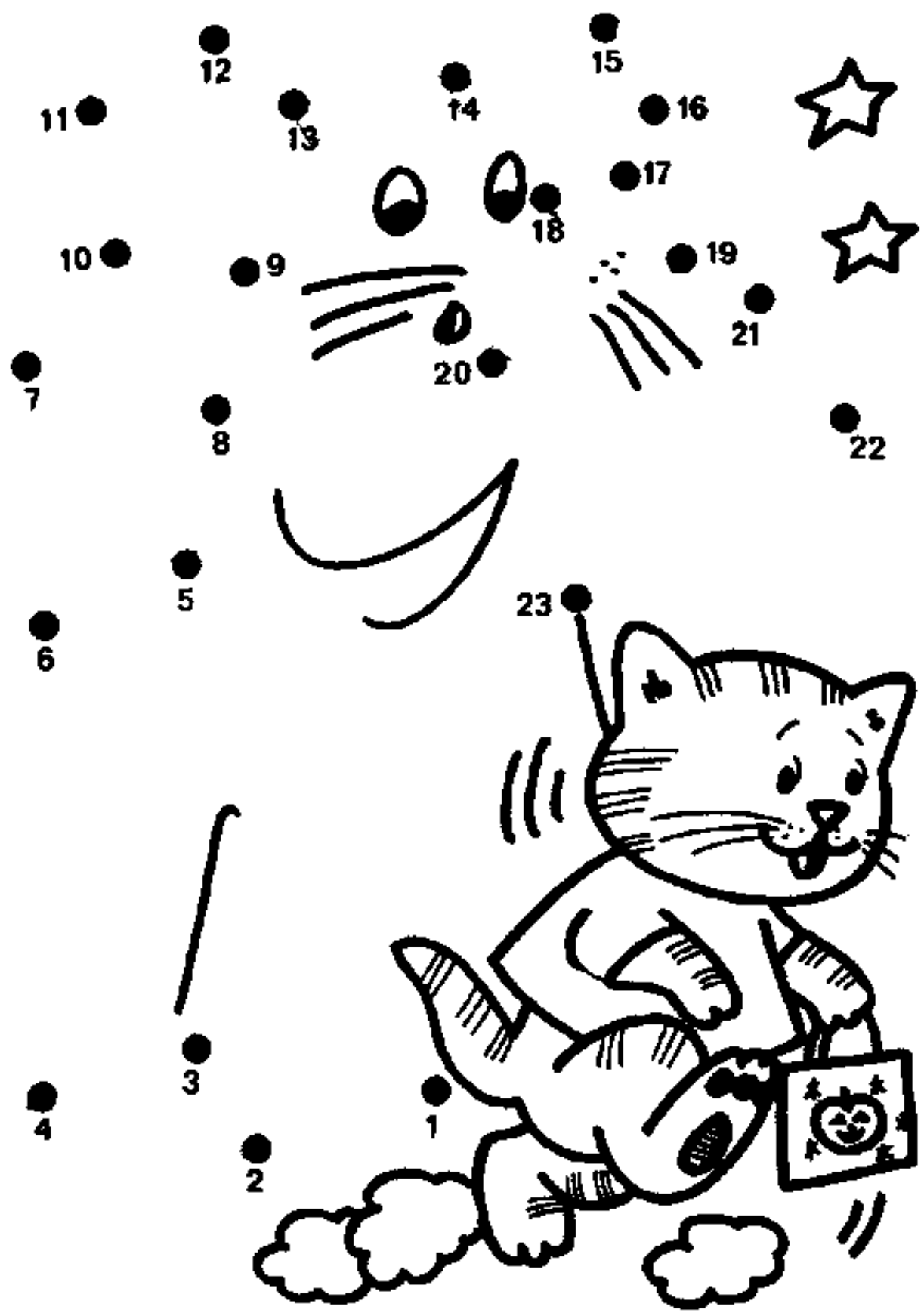

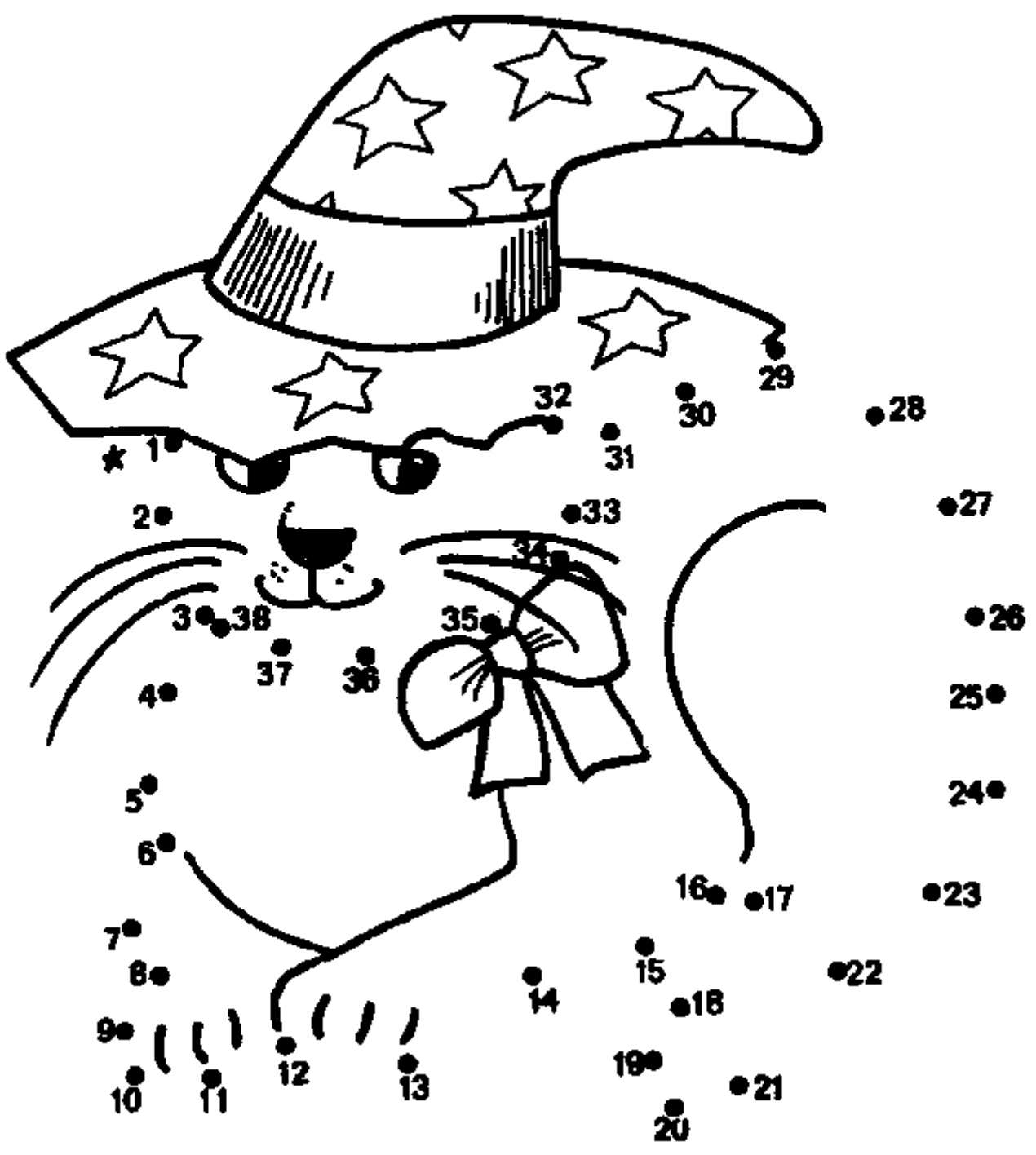

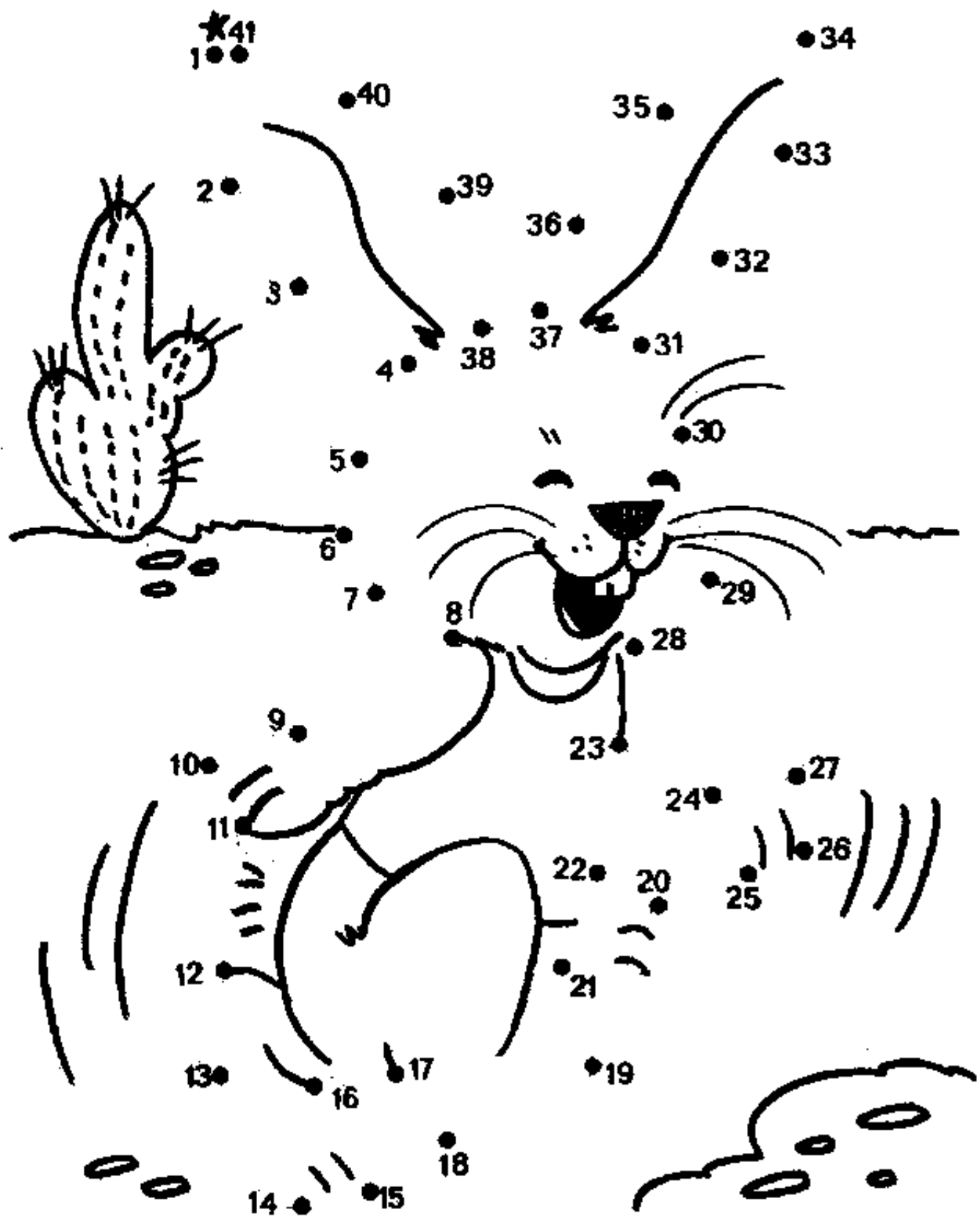







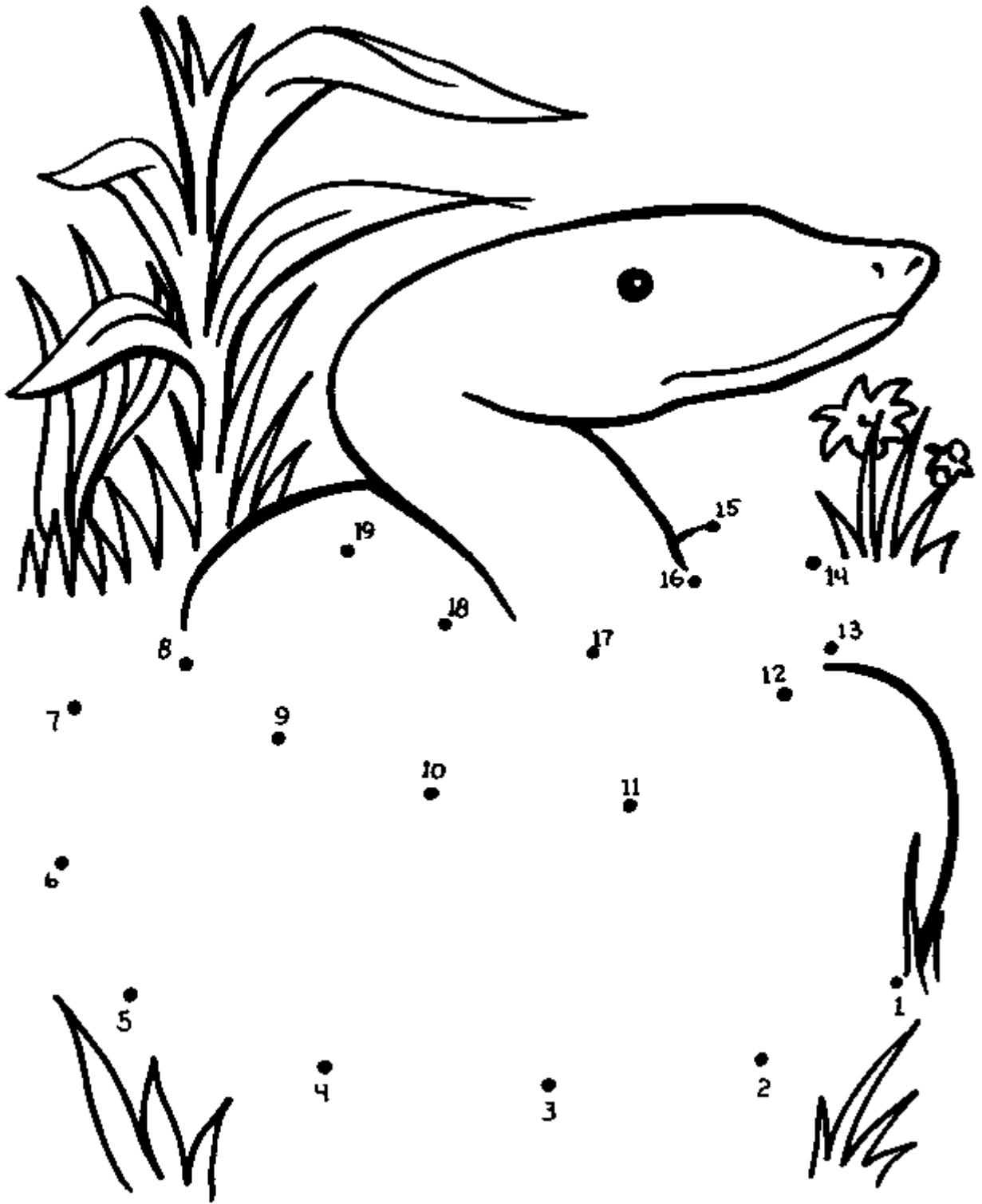





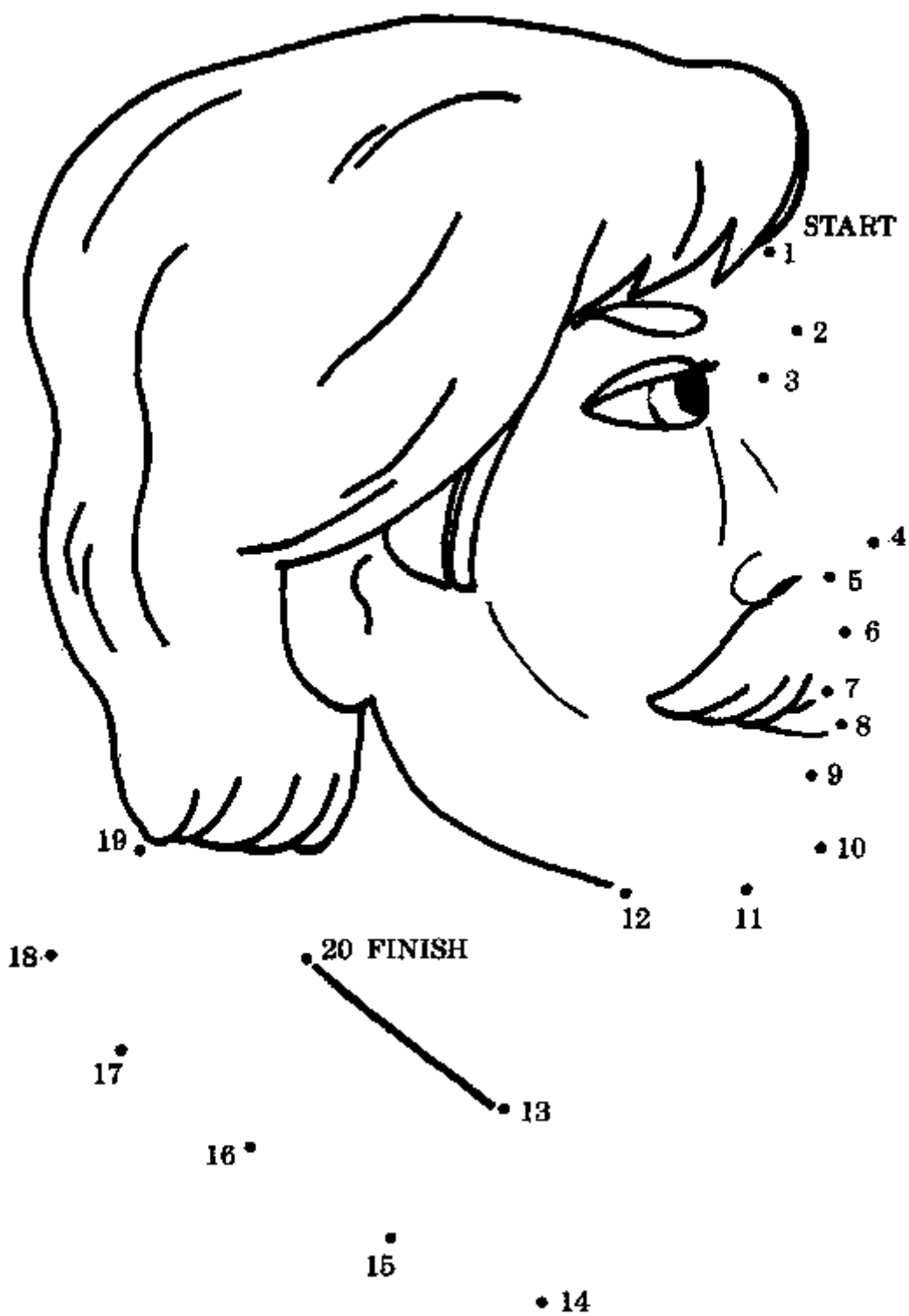

# CONNECT THE DOTS

Using a pencil, connect the dots beginning with number one to form/draw a machine that's very important to agriculture.

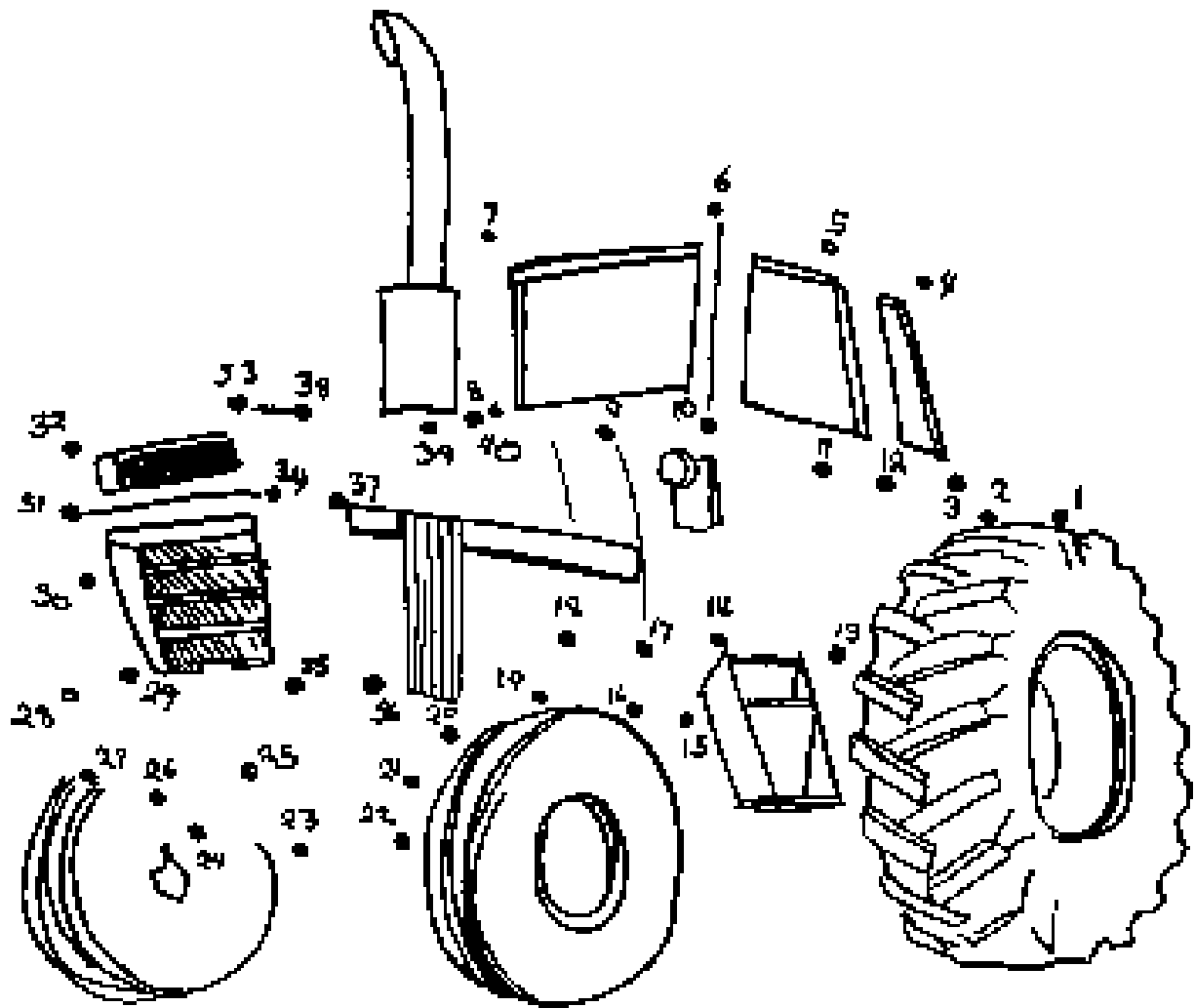

Read the word below. Then print the word.

---

---

---







